

2014

E-servqual and satisfaction analysis of retail foreign exchange company

Hadjisophocle, Vasilis

Business Administration Program, School of Economics Sciences and Business, Neapolis University Paphos

<http://hdl.handle.net/11728/6692>

Downloaded from HEPHAESTUS Repository, Neapolis University institutional repository



E-SERVQUAL AND SATISFACTION ANALYSIS OF RETAIL FOREIGN EXCHANGE COMPANY

By

VASILIS HADJISOPHOCLE

MASTER IN BUSINESS ADMINISTRATION

Neapolis University Pafos

Pafos, Cyprus

2013

Submitted to the Faculty of NEAPOLIS UNIVERSITY PAFOS

in partial fulfillment of

the requirements for

the degree of

Master in Business Administration

Page intentionally left blank

E-SERVQUAL AND SATISFACTION ANALYSIS OF RETAIL FOREIGN EXCHANGE COMPANY

Dissertation Approved by Dr. John Politis

Advisor

Dr. John Politis

Committee Member

Dr. John Politis

Program Director

Dr. John Politis

Page intentionally left blank

Student Declaration

I, Vasilis Hadjisophocle, declare that no part of this project has been submitted in support of an application for any other degree or qualification at this or any other institute of learning. Apart from those parts of the project containing citations to the work of others, this project is my own unaided work.

Date: ___/___/_____

Signed: _____

Page intentionally left blank

Acknowledgements

I would like to express my appreciation to my supervisor Dr. John Politis. His support and guidance were significant and valuable. Our collaboration was brilliant where I gained important skills and knowledge.

Moreover, I am thankful to all academic staff of Neapolis University that helped me receive the fundamental knowledge used to compose this dissertation. In addition, I also appreciate all the support and technical staff of Neapolis University that assists with the services and facilities to complete this dissertation.

Furthermore, I would like to thank Dr. Andreas Loizides (CIO of XM), and the rest of the XM's management team for allowing me to conduct this survey using XM's customer base.

Last, I'm grateful to my family and friends for all their support, understanding, and the enormous efforts to inspire me.

Page intentionally left blank

Abstract

Purpose: To quantify the service quality of an online financial institution (XM), and to conclude to the most important service quality dimension that contributes to customer satisfaction.

Methodology: Firstly, identifying the ServQual dimensions that describe the service quality of an online financial institution. Secondly, to compose and distribute a questionnaire with ServQual dimensions and customer satisfaction dimension. Last, to conduct ServQual analysis and correlate with customer satisfaction.

Results: ServQual results showed that XM's service quality are near perfect. Thus, correlating ServQual with customer satisfaction pointed to the most important dimension (Trust), which contributes the most for customer satisfaction. Moreover, the rest of the dimensions were proven also significant in customer satisfaction. A balance of all dimensions is required for best results since of inter-correlation between the dimensions.

Limitations: Low response rate of the questionnaire, which might have caused biased answers. Moreover, the questionnaire included negative questions, which might have caused participant confusion. Last, English was the only language used for the questionnaire, since the target audience was multilingual.

Page intentionally left blank

Table of Contents

| | | |
|----------|---|-------------|
| 1 | Introduction | 1-1 |
| 1.1.1 | <i>Accounts Type and Leverage.....</i> | 1-2 |
| 1.2 | Aims and Objectives..... | 1-2 |
| 1.3 | Project Structure..... | 1-3 |
| 2 | Literature Review | 2-5 |
| 2.1 | Quality..... | 2-5 |
| 2.2 | Traditional Service Quality Model..... | 2-6 |
| 2.2.1 | <i>Tangibles.....</i> | 2-10 |
| 2.2.2 | <i>Reliability.....</i> | 2-10 |
| 2.2.3 | <i>Responsiveness.....</i> | 2-11 |
| 2.2.4 | <i>Assurance.....</i> | 2-12 |
| 2.2.5 | <i>Empathy.....</i> | 2-12 |
| 2.3 | ServQual, Difficulties, and E-Service Industry | 2-13 |
| 2.4 | E-Service Quality Dimensions | 2-15 |
| 2.4.1 | <i>Reliability.....</i> | 2-15 |
| 2.4.2 | <i>Responsiveness.....</i> | 2-16 |
| 2.4.3 | <i>Communication.....</i> | 2-17 |
| 2.4.4 | <i>Trust.....</i> | 2-18 |
| 2.4.5 | <i>Website Content and Functionality – Product Portfolio.....</i> | 2-19 |
| 2.4.6 | <i>Website Ease of Use.....</i> | 2-20 |
| 2.5 | Similarities & Differences of Traditional ServQual and Propose E-ServQual | 2-21 |
| 2.6 | Customer Satisfaction and Loyalty..... | 2-22 |
| 3 | Methodology | 3-23 |
| 3.1 | Purpose of Research..... | 3-23 |
| 3.2 | Research Approach | 3-24 |
| 3.3 | Research Strategy | 3-25 |
| 3.4 | Sampling and Sample size analysis | 3-27 |
| 3.4.1 | <i>Sample Size Analysis / Power Analysis.....</i> | 3-27 |
| 3.5 | Questionnaire | 3-28 |
| 3.6 | Questions Coding | 3-29 |
| 3.7 | Methods of analysis | 3-30 |
| 3.8 | Ethical Considerations..... | 3-31 |

| | | |
|----------|---|-------------|
| 4 | Results Analysis | 4-33 |
| 4.1 | Demographics..... | 4-33 |
| 4.2 | General Demographics | 4-34 |
| 4.2.1 | <i>Country Demographics</i> | 4-35 |
| 4.3 | XM-Specific Demographics..... | 4-36 |
| 4.4 | Reliability, Factor analysis, and Sample Size | 4-37 |
| 4.4.1 | <i>Sample Size Analysis</i> | 4-37 |
| 4.4.2 | <i>Factor and Reliability Analysis</i> | 4-37 |
| 4.5 | E-ServQual | 4-40 |
| 4.6 | Correlations – Satisfaction..... | 4-42 |
| 4.7 | Text Analysis..... | 4-43 |
| 5 | Discussion | 5-47 |
| 6 | Conclusion and Final Thoughts | 6-53 |
| 6.1 | Achievements..... | 6-53 |
| 6.2 | Limitations and Further work..... | 6-53 |
| 6.3 | Conclusion..... | 6-54 |
| 7 | References | 7-55 |
| 8 | Appendices | 8-61 |
| 8.1 | Appendix A – Traditional ServQual Questionnaire | 8-61 |
| 8.2 | Appendix B – e-ServQual Questionnaire | 8-64 |
| 8.3 | Appendix C – Coding Table | 8-73 |
| 8.4 | Appendix D - Factor Analysis | 8-74 |

List of Figures

| | |
|--|------|
| Figure 1 - Service Quality Model – Gaps - (Parasuraman et al., 1985 p.44, 1991 p.337)..... | 2-8 |
| Figure 2 - Importance-Performance Matrix Template | 3-31 |
| Figure 3 - Questionnaire Participants | 4-33 |
| Figure 4 - General Demographics | 4-34 |
| Figure 5 - Responses by Continent | 4-35 |
| Figure 6 - XM/Trading Specific Demographics | 4-36 |
| Figure 7 - Factor and Reliability Analysis | 4-39 |
| Figure 8 - Importance Performance Matrix | 4-41 |
| Figure 9 - Radar Chart | 4-41 |
| Figure 10 - Text Analysis | 4-45 |

Page intentionally left blank

List of Tables

| | |
|--|------|
| Table 1 - ServQual Dimensions | 2-9 |
| Table 2 - ServQual versus E-ServQual Dimensions | 2-21 |
| Table 3 - Qualitative versus Quantitative approach (Chisnall, 2004, p.216-217) | 3-24 |
| Table 4 - Research Strategies Comparison - (Yin, 1994, p.8) | 3-26 |
| Table 5 - General Demographics | 4-34 |
| Table 6 - Top Countries Demographics | 4-35 |
| Table 7 - XM/Trading Specific Demographics..... | 4-36 |
| Table 8 - e-ServQual Results | 4-40 |
| Table 9 - Importance Correlation..... | 4-42 |
| Table 10 - Performance and Satisfaction Correlation Table..... | 4-42 |
| Table 11 - Importance of ServQual dimensions based on customer responses | 5-48 |
| Table 12 - Importance of ServQual dimensions based on correlation with Customer Satisfaction | 5-48 |
| Table 13 - Factor Analysis - Importance - Question 8 - 28 | 8-74 |
| Table 14 - Factor Analysis - Importance - Question 30 - 38 | 8-76 |
| Table 15 - Factor Analysis - Performance - Question 8 - 28..... | 8-77 |
| Table 16 - Factor Analysis - Performance - Question 30 - 38..... | 8-78 |
| Table 17 - Factor Analysis - Satisfaction - Questions 40 - 46..... | 8-78 |

Page intentionally left blank

1 Introduction

Quality is very important for any company since it is commonly correlated with customer satisfaction, buyer's intention, and reuse of a product or service (Lee and Lin, 2005). Many quality gurus tried to describe and explain quality. Quality can be either product based, or service based. Service based quality is non-tangible and it is harder to measure and evaluate (Zeithaml, 1981). The purpose of this study is to find a method to evaluate service quality. Parasuraman et al. (1985) proposed a method (ServQual) of evaluating service quality. This study will focus on adapting the ServQual model, and adjusting it so it will be useful in measuring online service quality, and more specifically, the service quality of an online financial institution.

This project will aim to evaluate the service quality of XM. XM is a retail forex broker, and belongs to the category of online financial institutions. XM provides online financial services to customers willing to exchange currencies, commodities, metals, indices and energies. In other words, XM's customers deposit money within an XM account, and from that account they can trade Forex, etc. 24/5 (From Monday-Friday). XM is online based, which means that except of educational and promotional events, customers do not have any "tangible" contact with XM's employees. The main communication channels between XM and XM's clients are emails, online chat support, and telephone communication.

Through research, a hybrid ServQual model was generated, which helped us in measuring online service quality. The main reason is that ServQual model proposed by Parasuraman et al. (1985) was based on non-online companies. The new hybrid ServQual, serves the purposes of an online financial institution, which also accommodates an extra dimension of "customer satisfaction". This will provide additional understanding of the importance of the ServQual dimensions.

The results of this study, show that XM is taking service quality in a serious manner. In other words, XM's ServQual results are at the appropriate levels. Moreover, this study allows XM to identify the most important dimensions, so it can allocate more resources in improving. Trust is by far the most important dimension. Furthermore, the rest of the dimensions are important as well, and contribute to customer satisfaction in a big degree. Last, all dimensions are inter-

correlated, which means that XM should balance those dimensions in order to achieve better customer satisfaction.

1.1.1 Accounts Type and Leverage

In order to better understand some terms used in this study, a brief explanation of XM account types and what is leverage will take place below.

XM trading platform allows opening positions, by lot sizes. A lot size specifies an amount of money in the first currency of the currency pair. In micro accounts, one lot is 1,000, and a standard account means that one lot is 100,000 (“XM Account Types”, 2013). For example, if we have a micro account and we buy 1 lot of EURUSD that means that we pay 1,000 EUR to buy the equivalence to USD.

Leverage according to “XM Account Leverage” (2013) is:

Using leverage means that you can trade positions larger than the amount of money in your trading account. Leverage amount is expressed as a ratio, for instance 50:1, 100:1, or 500:1. Assuming that you have \$1,000 in your trading account and you trade ticket sizes of 500,000 USD/JPY, your leverage will equate 500:1.

1.2 Aims and Objectives

The aim of this project is to assess the service quality of XM. Moreover, this project aims to identify the area/dimension where XM should improve the most.

In order to achieve the aims of this project, the following objectives should be addressed:

- Through research, identify the best model to be used to measure service quality of XM
- Conclude with a set of survey questions that will explain customer satisfaction

- Determine the dimensions that will be used for measuring service quality in online financial institutions
- Identify which dimensions are valid and can be used in measuring the service quality of XM
- Measure the service quality in accordance with the derived dimensions
- Identify which of the valid dimensions contributes the most to customer satisfaction
- Identify what actions/improvements XM should implement

1.3 Project Structure

The structure of the report will be the following:

- Introduction – (Current Chapter) – Will give some background information on both service quality and XM
- Literature Review
 - General research about quality
 - Explain and compare models of measuring quality
 - Deeper explanation of the most used model (ServQual)
 - Deeper explanation of various dimensions used specifically in online ServQual
 - Research around customer satisfaction
- Methodology
 - Identify the purpose of research
 - Identify the research approach and research strategy that will allow us to fulfill this project's aims and objectives
 - Identify validation techniques that will prove the validity of the results
 - Provide the methods of data analysis (ServQual and Correlations)
- Results Analysis
 - Present demographics
 - Present validation results, and prove the validity of the data and dimensions
 - Present ServQual results
 - Present Correlations

- Present Text Analysis
- Discussion
 - Discuss the gathered results
 - Compare and discuss the results with the literature
 - Propose improvements
- Conclusion
 - Present the achieved aims and objectives
 - Present the limitations of this study and propose future work
 - Conclude this study

2 Literature Review

This literature review will focus on identifying relevant quality dimensions around service quality. Initially, traditional service quality dimensions will be analyzed, and then more modern, specifically for online businesses dimensions will also be analyzed.

2.1 Quality

Quality is a term that does not have a standard definition. Gurus of Quality like Juran and Godfrey (1998), Feigenbaum (2004), (Crosby, 1995), Ishikawa and Ishikawa (1988), Taguchi (1986), and Deming (2000) tried to define and describe quality. The following are some of the statements that Quality Gurus said about quality.

- Quality is Fitness for use - (Juran and Godfrey, 1998)
- Quality means conformance to requirements - (Crosby, 1995)
- The total composite product and service characteristics of marketing, engineering, manufacture, and maintenance through which the product and service in use will meet the expectations of the customer - (Feigenbaum, 2004)
- The most economical and useful a customer requires - (Ishikawa, 1988)
- The efficient production of the quality that the market expects - (Deming, 2000)
- Uniformity around a target value - (Taguchi, 1986)

As it can be seen from the above statements, quality is often measured according to customer expectations. As Crosby (1995) state's quality is related to customer requirements, and thus with customer expectations. Moreover, Feigenbaum (2004) states that quality is meeting the customer expectations; Deming (2000) states that quality is directly related with what the market expects. To conclude, all of the above statements are somehow related to meeting or exceeding customer requirements and expectations. This study will be focused on measuring quality in relation to customer's expectations.

Quality is a wide subject and can be related to not only tangible, but also intangible products. It can be product-based quality, or service-based quality. In this case, service-quality will be further analyzed.

Since service quality is a non-tangible product, it is difficult to measure and evaluate (Zeithaml, 1981). Moreover, since services are heterogeneous, their performance varies from customer to customer, producer to producer, and of course day to day (Parasuraman et al., 1985). Last, since production and consumption of services are inseparable, services cannot be guaranteed consistency like as products can have. For all these different reasons, service quality is hard to be evaluated (Parasuraman et al., 1985). The purpose of this study is to find a method to evaluate service quality. Parasuraman et al. (1985) proposed a method (ServQual) of evaluating service quality. ServQual is directly related to the customer's expectations, which is widely mentioned by the Quality Gurus (mentioned at the beginning of this sub-chapter). ServQual is a model of measuring service quality and was introduced before the rise of the online organizations, thus this study will refer to that model as "Traditional Service Quality Model".

2.2 Traditional Service Quality Model

By using the term traditional service quality, we are referring to the service quality of all non-online based companies. Most services cannot be counted, measured, inventoried, tested, or verified, thus most services are intangible. Because of their intangibility, it is very hard to measure, and understand service quality (Zeithaml, 1981). But there are numerous research discussing service quality, and ways to evaluate it (Zeithaml, 1981). For example, Parasuraman et al. (1985) states that quality is a comparison between expectations and performance (Parasuraman et al., 1985). Based on the above statement, a Service Quality (ServQual) model was introduced.

ServQual is one of the most well-known and discussed models in the industry (Sohn and Tadisina, 2008). Carman (1990); Cronin and Taylor (1992,1994); Finn and Lamb (1991); and Parasuraman et al. (1991) are some of the many researchers that confirm the validity of the ServQual. In contrast of ServQual, some other models were introduced; for example ServPref that was introduced by Cronin and Taylor (1992, 1994). Moreover, some researchers, extended

the ServQual model to make it more applicable to online businesses; Li and Suomi (2009), Parasuraman (2005), Yang and Fang (2004) and Yang et al. (2004) are some of the researchers that extended this model to make it suitable for online organizations. Further analysis and comparison of related researchers will be made in subchapter 2.3. The rest of this subchapter will analyze the traditional ServQual model proposed by Parasuraman et al. (1985) since this is the base model of more modern quality measuring models.

Parasuraman et al. (1985, p.44) identifies five gaps that lie in an organization. These gaps need to be addressed in order to meet customer needs. The gaps, as shown in Figure 1, are:

- Gap 1: Difference between customer expectations and management perception of consumer expectations. It is the difference of what customers actually expect, and what the managers of the organization believe that customers expect.
- Gap 2: It is the difference in management perception of consumer expectations and the translation of perceptions into service quality specifications.
- Gap 3: It is the difference of translated service quality specifications, and the actual product delivered.
- Gap 4: It is the gap of the actual product delivered, and the external communication with customers. In fact, it is the difference of the communicated and the actual product.
- Gap 5: The gap, used in ServQual model, which examines the difference between expected and perceived quality.

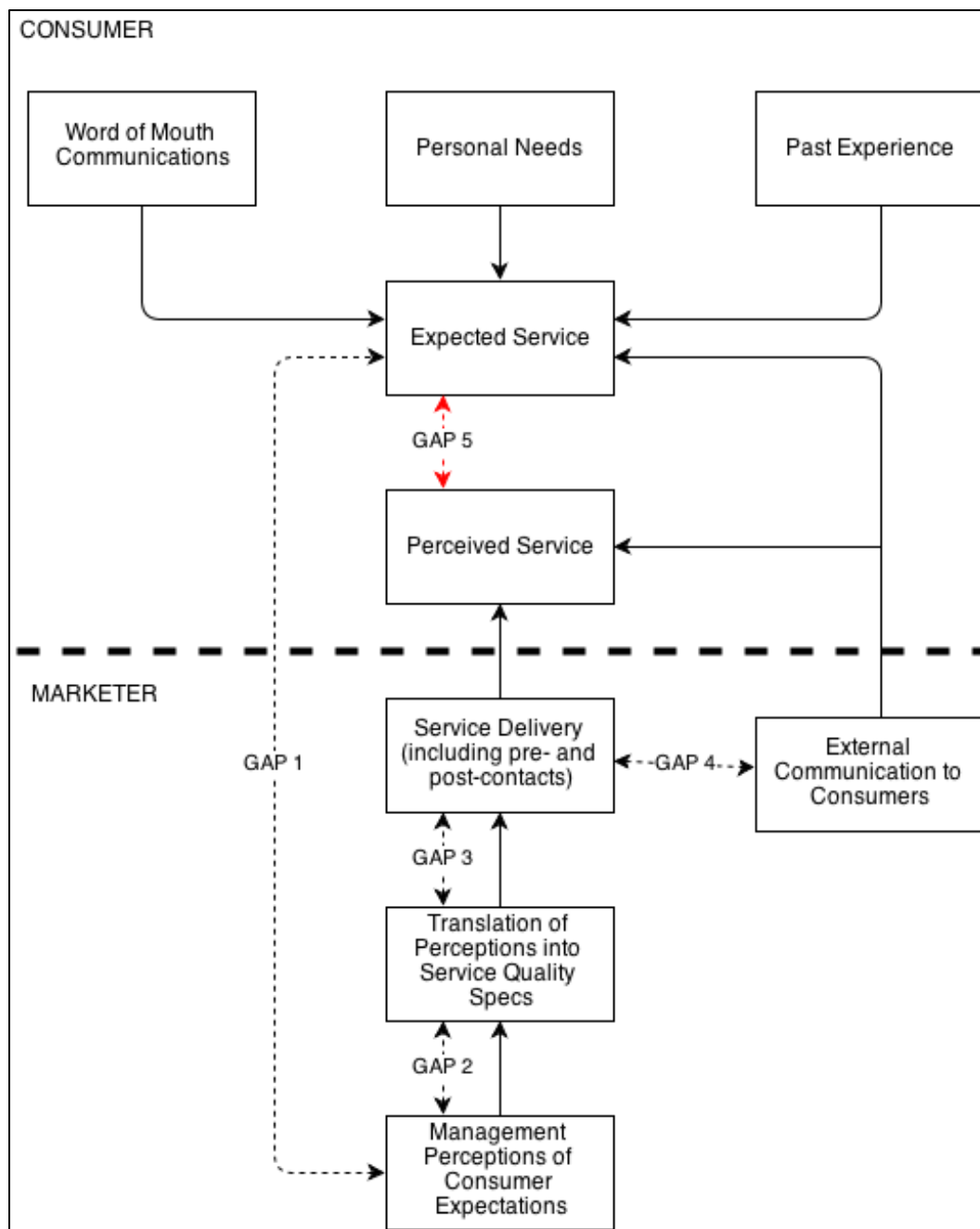

Figure 1 - Service Quality Model –Gaps - (Parasuraman et al., 1985 p.44, 1991 p.337)

Gap 5, is a function of all other gaps together ($GAP\ 5=f[GAP1, GAP2, GAP3, GAP4]$). As Gap 5 overlaps all other four gaps, ServQual model takes into consideration GAP 5 only (Parasuraman et al., 1985). Gap 5 is the distance between customers' expectations and perception about service quality. Based on Figure 1, expected service is formed by past experience, word of mouth, personal needs, and external communication. On the other hand, perceived service is formed by external communication and actual product delivered. In order to assess this gap, a ServQual questionnaire was created (Parasuraman et al., 1985).

The initial ServQual questionnaire was composed of 97 statements regarding service quality that customers expected, and another 97 statements regarding perceived service quality. Those 97 pairs of statements composed 10 dimensions of service quality; Tangibles, Reliability, Responsiveness, Communication, Credibility, Security, Competence, Courtesy, Understanding the customer, and Access (Parasuraman et al., 1985, p.47).

After collection of the data, validity tests were conducted and Parasuraman et al. (1988) presented five final dimensions; Tangibles, Reliability, Responsiveness, Assurance, and Empathy. Those 5 dimensions were composed of 22 pairs of questions (Expected and Perceived service quality). Respondents of the questionnaire, select their level of agreement for those 22 pairs of statements. The rating was based on a 7-point Likert scale, ranging from “Strongly Disagree” to “Strongly Agree”. These 22 pairs of questions composed the final ServQual model presented in (Parasuraman et al., 1988).

Table 1 shows both the initial 10-dimensions of ServQual, and how later on only five remain. It can be seen that Communication, Credibility, Security, Competency, and Courtesy were combined into Assurance. Moreover, it can be seen that ‘Understand the customer’, and ‘Access’ were combined into Empathy. Not only the dimensions shrink, but also the amount of statements was reduced from 97 to 22. (Parasuraman et al., 1985, 1988)

Table 1 - ServQual Dimensions

| 10-Dimensions | 5-Dimensions |
|-------------------------|----------------|
| Tangibles | Tangibles |
| Responsiveness | Responsiveness |
| Reliability | Reliability |
| Communication | Assurance |
| Credibility | |
| Security | |
| Competency | |
| Courtesy | |
| Understand the customer | Empathy |
| Access | |

According to Parasuraman et al., (1985, 1988), ServQual (SQ) is a function of the gap between expected (E) and perceived (P) service quality. Service Quality (SQ) can be calculated by subtracting customers’ perception (P) from customers’ expectation (E) (Buttle, 1996). In

general, “SQ=P-E” is calculated for each statement, and for each respondent. Then, an average of each dimension is calculated.

In the following sub-chapters, the five-dimensions of the final ServQual are further explained.

2.2.1 Tangibles

Most services are intangibles, but sometime they have a tangible part. Tangibles factors include visual appealing of buildings, employees or materials.

Statements included in the tangible dimension are: (Parasuraman et al., 1988)

- Up-to-date equipment
- Physical activities should be visually appealing
- Employees should be well dressed and appear neat
- The appearance of the physical facilities of these firms should be in keeping with the type of services provided.

The above statements are listed in “

Appendix A – Traditional ServQual Questionnaire”, and are the statements from 1 to 4.

The tangible dimensions of a service-based organization, is the only part that a visual contact exists between customer and organization. Therefore, it is needed to excel in this area in order to make a good impression to the customers (Sohn and Tadisina, 2008).

Tangible is an important dimension that is discussed in the literature. As Zeithaml (1981) states, if an organization wants to position its service as a high-quality offering, they should match their physical facilities to the anticipated level of quality.

2.2.2 Reliability

Parasuraman et al. (1985, 1988) states “reliability involves consistency of performance and dependability”. According to Parasuraman et al. (1985, 1988) reliability is one of the most

important dimensions of ServQual. Other studies such as Alanezi's et al. (2010) found that 15 other studies confirm that Reliability is one of the most valid and discussed variable of ServQual.

Statements included in the Reliability dimension are: (Parasuraman et al., 1988)

- When these firms promised to do something by a certain time, they should do so
- When customers have problems, these firms should be sympathetic and reassuring
- These firms should be dependable
- They should provide their services at the time they promise to do so
- They should keep their records accurately

The above statements are listed in “

Appendix A – Traditional ServQual Questionnaire”, and are the statements from 5 to 9.

2.2.3 Responsiveness

Responsiveness indicates the degree to which a service provided is helpful and in prompt time (Alanezi et al., 2010). “Responsiveness” dimension was also discussed and considered as valid in 15 studies that Alanezi et al. (2010) reviewed (out of 32). There are numerous other studies e.g. (Lee and Lin, 2005) that found a positive co-relation between responsiveness and overall service quality.

Statements included in the Responsiveness dimension are: (Parasuraman et al., 1988)

- They should not be expected to tell customers exactly when services will be performed
- It is not realistic for customers to expect prompt service from employees of these firms
- Their employees do not always have to be willing to help customers
- It is okay if they are too busy to respond to customer request promptly

The above statements are listed in “

Appendix A – Traditional ServQual Questionnaire”, and are the statements from 10 to 13.

2.2.4 Assurance

The dimension of assurance refers to the impression of security and trust that employees provide to customers (Parasuraman et al., 1988).

Statements included in the Assurance dimension are: (Parasuraman et al., 1988)

- Customers should be able to trust employees of these firms
- Customers should be able to feel safe in their transactions with these firms' employees
- Their employees should be polite
- Their employees should get adequate support from these firms to do their jobs well

The above statements are listed in “

Appendix A – Traditional ServQual Questionnaire”, and are the statements from 14 to 17.

Assurance is a hybrid dimension composed of parts of communication, credibility, security, competence, and courtesy (as shown in Table 1). This dimension is derived after scale purification performed by Parasuraman et al. (1988) at the initial 10-dimension ServQual by Parasuraman et al. (1985).

2.2.5 Empathy

The dimension of empathy refers to caring and paying individual attention to customers (Parasuraman et al., 1988).

Statements included in the Empathy dimension are: (Parasuraman et al., 1988)

- These firms should not be expected to give customers individual attention
- Employees of these firms cannot be expected to give customers personal attention
- It is unrealistic to expect employees to know what the needs of their customers are
- It is unrealistic to expect these firms to have their customers' best interests at heart
- They shouldn't be expected to have operating hours convenient for all their customers.

The above statements are listed in “

Appendix A – Traditional ServQual Questionnaire”, and are the statements from 18 to 22.

Empathy is a hybrid dimension composed of parts of Understanding/Knowing Customers, and Access (as shown in Table 1). This dimension is derived after scale purification performed by Parasuraman et al. (1988) at the initial 10-dimension ServQual by Parasuraman et al. (1985)

2.3 ServQual, Difficulties, and E-Service Industry

Cronin and Taylor (1992, 1994) raised validity issues about ServQual and proposed their own ServPerf model. ServPerf stands for Service Performance. ServPerf model proposes that service quality is based on a firm’s performance and not the difference between expectations and performance (ServPerf=Performance instead of ServQual=Expectations-Performance). They also proposed Weighted ServPerf, where importance is the weight of the performance (Quality=Importance*Performance). They still used the same questions as the initial ServQual model proposed by Parasuraman et al. (1988).

Similar to the marketing literature, validity of ServQual was raised in the Informational Systems (IS) literature. Van Dyke et al., (1997) argued that most of the problems arise from the subtraction of expected performance and actual performance. Van Dyke et al., (1997) support ServPerf and support that the “expectation” is very vague, thus ServQual is difficult to be applied in different industries. In response to Van Dyke et al., (1997), Pitt et al. (1997) argued about the superiority of ServQual over ServPerf. Pitt et al. (1997) defended ServQual since ServQual is a richer diagnostic tool than ServPerf.

Except of the arguments of service quality measurement (ServQual vs ServPerf), in the literature there are a lot of authors that are discussing about using different dimensions instead of the traditional ones proposed by Parasuraman et al. (1988). Sohn and Tadisina (2008) propose Trust, Customized Communication, Ease of Use, Website content and functionality, Reliability, and Speed of delivery as the appropriate dimensions to measure e-service quality. Sohn and Tadisina’s (2008) study was based on internet-based financial institutions and they state that both ServQual and ServPerf are not appropriate measures for internet markets. Moreover, they

state that internet markets differ from traditional ones in terms of human servers, and physical facilities.

Another similar study was based on internet-banking service industry (Yang et al., 2004). Internet banking was selected as it is very service-intensive industry. Initially, Yang et al. (2004) selected 17 dimensions around the literature, and run the questionnaire for 20 internet-based (or hybrid) banks. After validation of collected data, they concluded to 6 significant dimensions: Reliability, Responsiveness, Competence, Ease of Use, Product Portfolio, and Security (Yang et al., 2004).

Yang and Fang (2004) conducted another study around e-ServQual dimensions. This time the study was concentrated at internet securities brokerages. Yang and Fang (2004) picked 21 leading brokerages and conducted a quantitative analysis that included 16 e-service dimensions. The study concluded that all 16 dimensions are vital, since some of them are satisfiers, dissatisfiers, and some others both. Ideally, management should give priority to Responsiveness, Service and System Availability, Ease of Use, Timeliness, Access, Competence, and Security (Yang and Fang, 2004).

Additionally, there is also some bibliographical literature around e-ServQual. Li and Suomi (2009) reviewed 25 articles discussing about different ServQual dimensions specifically design for online organizations. Some of the organizations were online retailing, and some others were exclusive online services. Li and Suomi (2009) ended up proposing Website Design, Responsiveness, Reliability, Security, Fulfillment, Personalization, Information, and Empathy as the appropriate dimensions to measure e-ServQual.

Another strong evidence of the inappropriateness of the traditional ServQual, is the article by Parasuraman (2005). The same author that “invented” ServQual, revised it in 2005 and introduced E-S-Qual. Parasuraman (2005) identified the problems associated with ServQual and online business, and after the analysis of various e-service dimensions, Parasuraman (2005) concluded in the following E-ServQual dimensions: Efficiency, System Availability, Fulfillment, Privacy, Responsiveness, Compensation, and Contact. The first four dimensions are in a category called E-S-Qual, and the last three in a category called E-RecS-Qual. E-S-Qual have to do with pre-sales Service Quality. In contrast, E-RecS-Qual which stands for E-

Recovery-ServQual, is concentrated at after sales service, and ways to handle problems and compensate customers.

2.4 E-Service Quality Dimensions

For the purpose of this study, various dimensions of the above literature were considered, and after evaluation, some were selected to conduct this study. The selected dimensions are further analyzed in the following sub-chapters.

2.4.1 Reliability

Reliability is one of the dimensions inherited from the traditional ServQual (See subchapter 2.2.2 on page 2-10). In order to adjust the reliability dimension to online organizations, the System Reliability should also be considered. Thus, reliability is defined as consistency of performance and dependability (as the traditional ServQual), but also as the “ability of the company to perform the service accurately and dependably without system crash” (Sohn and Tadisina, 2008)

Some of the statements included in the e-ServQual literature of Reliability dimension are:

- (Sohn and Tadisina, 2008)
 - When the company promise to do something, it does so
 - The company keeps my records accurately
 - The company’s system is always working well
 - The account information is updated immediately as soon as the transaction is finished
 - The company provides real-time information
- (Yang et al., 2004)
 - The company performs the service correctly the first time
 - When the company promise to do something by a certain time, it does so
 - The company keeps my records accurately

The selected statements for reliability dimension are listed in “Appendix B – e-ServQual Questionnaire”, and are the statements from 8 to 11.

Reliability is not only one of the most vital dimensions of traditional ServQual (as stated in subchapter 2.2.2 on page 2-10), but is also crucial for online organizations too (Li and Suomi, 2009). In an online environment it is vital to make customers trust the organization to do what they ask, else the customers will be dissatisfied (Iwaarden et al., 2003).

2.4.2 Responsiveness

Responsiveness is one of the dimensions inherited from the traditional ServQual (See subchapter 2.2.3 on page 2-11). In e-services Responsiveness dimension is a much narrower concept than in traditional ServQual. The company should provide prompt service to customers that have problems and questions in order to make customers more comfortable in completing an online transaction (Li and Suomi, 2009). In the revised version of ServQual, Parasuraman (2005) describes Responsiveness of online organizations as “Effective handling of problems and returns through the site”

Some of the statements included in the e-ServQual literature of Responsiveness dimension are:

- (Sohn and Tadisina, 2008)
 - The company promptly informs customers when the service will be performed
 - I receive prompt responses for my requests
- (Yang et al., 2004)
 - Employees give me prompt service
 - I receive prompt responses to my requests by e-mail or other means
 - The company quickly resolves problems I encounter

The selected statements for Responsiveness dimension are listed in “Appendix B – e-ServQual Questionnaire”, and are the statements from 13 to 15.

Responsiveness apart of being one of the most vital dimensions of traditional ServQual (as stated in subchapter 2.2.3 on page 2-11), is very important for online organizations too (Li and Suomi, 2009). Responsiveness in an online organization can be achieved by automated or

human e-mail, telephone, or online chat responses, as well as show true interest in solving customer problems (Trudie et al., 2009)

2.4.3 Communication

Communication is one of the dimensions inherited from the traditional ServQual (See Empathy subchapter 2.2.5 on page 2-12). In e-services, empathy is the hardest to earn in contrast to traditional service since there is no face-to-face communication (Li and Suomi, 2009). Parasuraman (2005) describes communication (contact) as “The availability of assistance through telephone or online representatives”. Except the assistance and guidance provided by telephone or online representatives, empathy can be earned through designing a website in such a way that clients have the perception of personal attention (Iwaarden et al., 2003).

Some of the statements included in the e-ServQual literature of Communication dimension are:

- (Sohn and Tadisina, 2008)
 - The company gives me individual attention
 - The contact person understands my specific needs
 - The contact person is knowledgeable
 - It is very convenient to contact employees when I have complaints or questions
- (Parasuraman, 2005)
 - The site provides a telephone number to reach the company
 - The site has customer service representatives available online
 - It offers the ability to speak to a live person if there is a problem

The selected statements for Communication dimension are listed in “Appendix B – e-ServQual Questionnaire”, and are the statements from 17 to 20.

As stated above, empathy is harder to earn than in traditional services because of the absence of direct human contact. Thus, companies must aim at adequate contact, friendly complaint addressing, and to excel at giving personal attention (Li and Suomi, 2009)

2.4.4 Trust

Trust is a dimension that does not exist in traditional ServQual. Trust is commonly defined as the ability to be trustworthy (Sohn and Tadisina, 2008). Moreover, Trust can be divided into two aspects; financial security, and confidentiality (Sohn and Tadisina, 2008). Financial security refers to the absence of dangers and risks. Customers usually feel more risky in a virtual environment, especially in financial institutions, so making customers feeling less risky is vital (Li and Suomi, 2009). According to Roca et al. (2009) absence of Trust is one of the main reasons that customers are not engaged in completing a transaction with an online organization.

Some of the statements included in the e-ServQual literature of Trust dimension are:

- (Sohn and Tadisina, 2008)
 - I trust the company
 - I trust the e-services provided by the company
 - I am comfortable dealing with financial transactions with the company
 - The company will not misuse my personal information
 - The company will not misuse my accounting information
- (Yang et al., 2004)
 - The company will not misuse my personal information
 - I feel safe in my online transactions
 - I felt a secure in providing sensitive information (e.g. credit card number) for online transactions
 - I felt the risk associated with online transactions is low

The selected statements for Trust dimension are listed in “Appendix B – e-ServQual Questionnaire”, and are the statements from 22 to 28.

Since it is more likely for a potential customer to engage in a transaction with the company if the perceived trust is high; trust becomes highly important in online organizations (Roca et al., 2009). There are numerous articles in the literature that discuss the relation of trust, privacy, and security with online organizations, and especially e-commerce (Belanger et al., 2002; Roca et al., 2009; Udo, 2001).

2.4.5 Website Content and Functionality – Product Portfolio

Website Content and Functionality – Product Portfolio is a dimension that does not exist in traditional ServQual. According to Yang et al. (2004), customers are more prone to engage in transactions with an online organization if it offers a significant variety of products. Cho and Park (2001); Page and Lepkowska-White (2002) are a few of the literature that proved that “variety of products” is one of the main dimensions in keeping customers satisfied and adding value to the company. Moreover, convenience is really important in online organizations. This means that a customer will be more prone to engage in a transaction with a company if that company offers him other products that may interest him (Yang et al., 2004). Convenience can also serve as “appropriateness of webpage content” and/or various functions, and not products, offered by the website (Sohn and Tadisina, 2008). Various functions offered by a website, can be research tools, or online news, that will help a customer of a Forex broker to make a wiser investment (Sohn and Tadisina, 2008).

Some of the statements included in the e-ServQual literature of Website Content and Functionality – Product Portfolio dimension are:

- (Sohn and Tadisina, 2008)
 - The company provides many services that I am looking for
 - The company provides many options for delivery
 - The company maintains up-to-date webpages
 - The web pages have the contents that meet customers’ needs
 - The company’s webpages provide many useful tools such as stock screening tools, research tools, etc.
 - The company provides many useful services such as email subscription, net meeting forum, account alerts, etc.
- (Yang et al., 2004)
 - The company provides wide ranges of service packages
 - The company provides services with the features I want
 - The company provides most of the service functions that I need
 - All my service needs are included in the menu options

The selected statements for Website Content and Functionality – Product Portfolio dimension are listed in “Appendix B – e-ServQual Questionnaire”, and are the statements from 30 to 34.

2.4.6 Website Ease of Use

Website Ease of Use is a dimension that does not exist in traditional ServQual. Websites must be designed for customers’ ease of use. Sohn and Tadisina (2008) compares website content, design, and navigation as with a physical store environment. As the physical store environment influences the perceived image that a customer have for a company, the webpage should be also attractive, with appropriate content and navigability to attract customers’ attention (Sohn and Tadisina, 2008).

Rice (1997) conducted a survey among 87 webpages to find out the reasons why customers’ repeat a visit to a website. Content of a website had the highest correlation with repeated visits, which is related to “Website Content and Functionality – Product Portfolio” dimension discussed in 2.4.5. Moreover, enjoyable websites, and well-structured and organized websites were the second most important dimension. As Rice (1997) discussed, easy navigation and location of content and information has a high contribution into mass-market penetration.

According to Yang et al. (2004) customers chooses to terminate a transaction when they encounter difficulties navigating, or finding content in a website. Websites should be easy to understand and navigate. Additionally, information about products and services should be easily accessible. Adequate explanation is usually missing from online banks, or online brokers (Yang et al., 2004).

Some of the statements included in the e-ServQual literature of Website Ease of Use dimension are:

- (Sohn and Tadisina, 2008)
 - Using the company’s websites is complicated
 - Using the company’s websites requires a lot of effort
 - It is easy to complete a transaction through the company’s websites
- (Yang et al., 2004)
 - The organization and structure of online content were easy to follow

- It is easy for me to complete a transaction through my bank's Web site
- Using the bank's Web site requires a lot of effort

The selected statements for Website Ease of Use dimension are listed in “Appendix B – e-ServQual Questionnaire”, and are the statements from 36 to 38.

2.5 Similarities & Differences of Traditional ServQual and Propose E-ServQual

The proposed e-service quality model has a lot of similarities, but also some differences with the traditional service quality. Firstly, both traditional and online service quality models include dimensions for Reliability, Responsiveness, and Communication (Same as Empathy in traditional ServQual). Moreover, Assurance is unique for traditional ServQual. Tangible dimension in traditional ServQual is comparable with the website part of an online service provider (Li and Suomi, 2009). Tangible is not exactly identical with the website part, since a website has more components except website design. In a website, we include the ease of use, and product portfolio. The only comparable component of the ‘website content and functionality’ with the Tangible dimension is the website design. Last, Trust is unique to the online Service Quality model. Table 2 shows in summary the commonalities and differences of the two models.

Table 2 - ServQual versus E-ServQual Dimensions

| | ServQual | e-ServQual |
|---------------------------------------|----------------|--|
| Unique to Traditional ServQual | Assurance | |
| | Tangibles* | *Website Ease of Use *Website Content and Functionality |
| Common | Reliability | Reliability |
| | Responsiveness | Responsiveness |
| | Empathy | Communication |
| Unique to E-ServQual | | Trust |

* Not exactly identical since website part contains more components, except the website design

2.6 Customer Satisfaction and Loyalty

Customer satisfaction is directly related to Service Quality and is highly important. Extensive research about customer satisfaction has been in the field for more than thirty years (Kong et al., 2004). Customer satisfaction is the difference between customers' expectations and perceived performance (Tse and Wilton, 1988). Expectations are influenced by personal needs, past experience, and word of mouth (See Figure 1). Customers' satisfaction occurs when performance matches or exceeds expectations. Customers' dissatisfaction occurs when undesirable disconfirmation occurs (Pizam and Ellis, 1999). In general, customer satisfaction occurs when Gap 5 (discussed in 2.2) is very small or non-existence.

Customer's behavioral intention includes behavioral loyalty and attitudinal loyalty. The behavioral loyalty leads to repurchases and the attitudinal loyalty to word-of-mouth referrals (Durvasula S, 2004). There is extensive literature that correlates behavioral intention with ease of use, trust, and other s-ServQual dimensions (Roca et al., 2009).

Some of the statements included in the Customer Satisfaction/Behavioral Intention literature are:

- (Yang et al., 2004)
 - Overall, the service quality of my online company is excellent
 - Overall, my online company comes up to my expectations of what makes a good online supplier
 - Overall, I am very satisfied with the company
 - Overall, I am very satisfied with Internet-based transactions
 - Overall, I am very satisfied with the products/services offered by the company
- (Roca et al., 2009)
 - I will use the online trading systems on a regular basis in the future
 - I will frequently use the online trading systems in the future
 - I will strongly recommend others to use

The selected statements for Website Ease of Use dimension are listed in "Appendix B – e-ServQual Questionnaire", and are the statements from 40 to 46.

3 Methodology

This chapter describes the research methodology behind this study. It elaborates on the basis on which the study is based on, the formation of the survey and other methods used in this study.

3.1 Purpose of Research

Research is commonly categorized into various types depending on the nature of the research problem. Categories of research include exploratory, descriptive, or explanatory (Saunders et al., 2009; Yin, 1994).

According to Yin (1994), exploratory research, as the name denotes, is to gather information about an under-researched subject. The prime goal is to explore, develop knowledge and understand the subject. Research of the literature, interview with experts on the subject, and focus group interviews are some of the most common ways of conducting exploratory research (Saunders et al., 2009).

Descriptive research on the other hand, involves the description of the subject. It can be considered an extension of an explanatory study (Saunders et al., 2009). It can be either qualitative or quantitative. According to Zikmund (2003), descriptive research is used when the subject is known, but the researcher is not fully aware of the situation. Moreover, descriptive research will answer questions such as who, where, what, and how.

Last, explanatory research, or “causal research”, is being concerned with the causes. The main goal of that type of research is to explain one or more phenomena (Yin, 1994). Some of the questions that explanatory research can answer are: “Low payment can cause big employee turnover”, or “poor motivation can lead to big employee turnover”. Usually this type of research method is hypothesis testing using quantitative methods. According to Saunders et al. (2009) explanatory research gives emphasis on studying a subject in order to explain relations between the variables.

Research categories are not clearly bound and often used in conjunction (Saunders et al., 2009; Yin, 1994). Most often, descriptive and explanatory research are combined, and such studies are well known as “descripto-explanatory” studies (Saunders et al., 2009).

This research project aims to examine and describe the importance, as well as the satisfaction of various service quality dimensions. The difference of the importance and satisfaction (ServQual) will be a powerful tool to identify and describe the problems involved with service quality. Moreover, it will help us answer questions like “who is responsible”, “what is the problem”, and “where (functional unit) is the problem”. Moreover, this project aims to find possible relation between service quality variables and overall customers’ satisfaction. Considering both of the above, this study can be considered as a “descripto-explanatory” study.

3.2 Research Approach

There are two types of research approach, Quantitative approach, and Qualitative approach (Kothari, 2004). Quantitative approach can be considered as objective; while on the other hand, qualitative approach is more subjective (Smith, 1983). The reason is that Quantitative involves numerical and statistical representation/manipulation (objective), in contrast with Qualitative, which involves non-numerical examination and manipulation of the observations (subjective).

Table 3 - Qualitative versus Quantitative approach (Chisnall, 2004, p.216-217)

| | Qualitative | Quantitative |
|-----------|---|--|
| Objective | To gain qualitative understanding of the underlying reasons and motivations | To quantify the data and generalized results from sample to the population of interest |
| Sample | Small number of non-representational cases | Large number of representative cases |

| | Qualitative | Quantitative |
|-----------------|----------------------------------|------------------------------------|
| Data Collection | Unstructured | Structured |
| Data Analysis | Non-statistical | Statistical |
| Outcome | Develop an initial understanding | Recommend a final course of action |

Taking into consideration the table of Chisnall (2004) (Table 3), and since the main objective of this study is for statistical analyze and describes the service quality gap, then this research can be considered as Quantitative one. According to chapter 1.2, the objectives of this project are to statistically evaluate the service quality of XM, and to identify the key dimensions where XM should take action. Both of those aims, can be fulfilled by a quantitative approach. Moreover, since “more comments” fields will be provided, we will try to extract knowledge and manipulate the meaning of those fields. This small part of the research can be considered as qualitative.

3.3 Research Strategy

According to Yin (1994) there are 5 main research strategies:

- Experiment
- Survey
- Case Study
- History
- Archival Analysis

Each of them has its advantages and disadvantages. The selection is made upon the type of research question, upon the focus on historical or current phenomena, and if there is control over the actual behavior (Yin, 1994).

Table 4 - Research Strategies Comparison - (Yin, 1994, p.8)

| Strategy | Type of Research Question | Requires Control over Behavioral Events | Focus on Contemporary Event |
|-------------------|--------------------------------------|---|-----------------------------|
| Experiment | How, Why | Yes | Yes |
| Survey | Who, What, Where, How many, How much | No | Yes |
| Case Study | How, Why | No | Yes |
| History | How, Why | No | No |
| Archival Analysis | Who, What, Where, How many, How much | No | Yes/No |

As of Table 4, which was extracted from Yin (1994), the selection of the research strategy should be made. The selection of the research strategy will be made upon deducting/excluding inappropriate methods.

This type of research needs to focus on contemporary data, as we need to analyze the service quality gap that is present in the organization. Moreover, no previous historical data is available, thus, “History” research strategy is excluded.

Moreover, there is no control over any behavioral events, so “Experiment” research strategy is also excluded. Since knowing the statistics (how many, how much) in order to find the gap between expected and perceived service quality, “Case Study” strategy is also excluded. “Archival” strategy is also excluded from the list because there are not any secondary data to analyze.

Last, Survey is the remainder, which answers all the questions needed in order to conduct a service quality model. Through the survey method, quantitative data are needed to assess how big the gap between expected and perceived quality is. Since the survey's target audience is web-based an online survey tool will be used, and the survey will be delivered to them through their e-mail. For this purpose, SurveyMonkey (www.surveymonkey.com) will be used. SurveyMonkey satisfies all the needs, and provides all functionality needed to create the questionnaires. Moreover, data can be exported in excel, csv or SPSS format, which are appropriate formats to complete the results analysis. Since all needs are satisfied, and since XM has a premium account with SurveyMoney, it was selected as the survey tool that will be used in this research.

3.4 Sampling and Sample size analysis

Sampling will be based on "Probabilistic" sampling technique, which means that the sample is selected randomly to avoid any biases during the selection process (Saunders et al., 2009). The only selection is that the sample will be based only from XM's customer base. Last, the questionnaire will be available to them for 14 days. Based on Jill Z (2011) who conducted a study for surveymonkey.com, 91% of responses are collected within 2 week in contrast with 80% of collected responses in 1 week. Taking this study under examination, and after discussing with the marketing and research department of XM, 2 week availability period was selected.

3.4.1 Sample Size Analysis / Power Analysis

In order to find the appropriate sample size that will express XM's population (entire XM's customer base), a calculation of the minimum sample size is required. Based on Anderson et al., (2010, p.330) sample size can be calculated by the following formula:

$$n = \frac{\left(\frac{z\alpha}{2}\right)^2 p^*(1-p^*)}{E^2}$$

- n is the required sample size

- Z is the confidence level (converted through the Z statistical table, 95% confident interval = 1.96)
- P* is the percentage of population picking a choice
- E is the confident interval expressed in decimal

For the purpose of this study, these variables need to be set. A confident level of 95% is a sufficient and accepted confident level, thus Z=1.96. A confident interval of +-5% is also within acceptable limits. And since p* is unknown before conducting the study, and no previous samples are available, p* can be set to 0.50 which will result to the highest sample size (Anderson et al., 2010 p.330). Based on all the above the equation can be solved:

$$n = \frac{\left(\frac{z_{\alpha}}{2}\right)^2 p^*(1-p^*)}{E^2} = \frac{1.96^2 * 0.5 * 0.5}{0.05^2} = \frac{0.9604}{0.0025} = 384.16 = 385$$

The above formula explains that if a sample of 385 participants is received, then 95% of the population will answer the same answers in the interval of +-5%. This indicates very accurate results.

3.5 Questionnaire

Based on the literature review conducted; reliability, responsiveness, communication, trust, website content and functionality, website ease of use and satisfaction are one of the dimensions used for measuring e-service quality. In order to compose a survey, questions for each dimension should be gathered. For this purpose, a careful analysis of (Roca et al., 2009; Sohn and Tadisina, 2008; Yang et al., 2004) occurred. After selecting questions suitable for an online financial broker, a list was handed to the Management of XM. After careful examination, some of the questions were excluded because of un-suitability and the resulting set of questions, composed the questionnaire.

The final set of questions will consist 47 questions. Seven of them were demographic questions, and another seven of them were questions that asked participants to provide further comments

for each of the seven dimensions. Moreover, another seven questions, try to describe the satisfaction variable. This leads to:

- 7 Demographic questions
- 7 “Further Comment” questions
- 7 Satisfaction (Desired Outcome) questions
- 26 ServQual questions splintered across the following 6 Dimensions:
 - 4 Reliability questions
 - 3 Responsiveness questions
 - 4 Communication questions
 - 7 Trust questions
 - 5 Website Content and Functionality questions
 - 3 Website Ease of Use questions

“Further Comment” questions are qualitative-based questions, and they are going to be used for further and deeper explanation of ServQual. Satisfaction questions will be used in order to correlate XM’s performance of the various ServQual Dimensions with satisfaction. Satisfaction questions are using a 7-point Likert scale ranging from 1 “Strongly Disagree” to 7 “Strongly Agree”.

The 26 ServQual questions are “double questions”. Double questions mean that for each question, two 7-point Likert scales are provided. One 7-point scale is about the importance, and another one for the XM’s performance. For example, a participant should choose how important is a question for him (from 1 to 7), and how XM performs in that field (from 1 to 7). Thus, the 26 ServQual questions can be considered as 52 questions in total.

The full structure of the questionnaire can be found in “Appendix B – e-ServQual Questionnaire”.

3.6 Questions Coding

In order for the questions to be meaningful in the statistical analysis, they have to be grouped into e-ServQual dimensions. “Appendix C – Coding Table” summarize the question, and defines

the e-ServQual dimension which they belong to. Question 37 and 38 were inverted since they have negative meaning. The reversion occurred in order to have the same scale as the rest of the questions.

3.7 Methods of analysis

Initially, various validity and reliability checks will be conducted in order to analyze the robustness of our sample, and of our questionnaire. Some of the tools that will help are:

- Sample/Power size analysis
- Factor analysis, using SPSS
- Reliability analysis (Cronbach Alpha), using SPSS

The sample size analysis will help to understand if we have a representative number of samples so our results are meaningful and can represent the company's population (client base). Moreover, factor analysis will help to identify if the questions can form and successfully represent an e-ServQual dimension. Last, reliability analysis will give an indication of the reliability and consistency of each dimension.

Furtherance of the reliability and validity tests, this study will be concentrated at correlating various dimensions between each other, and especially satisfaction with the rest of the dimensions. This will help us identify which of the dimensions are more important, and contribute more to the overall customer satisfaction.

Last, and more importantly, ServQual analysis will occur. ServQual analysis is actually the difference between perceived and expected service quality. This will indicate where the organization is performing well, and where is underperforming (based on user's expectations).

To better illustrate ServQual, Importance-Performance matrix will be used. Importance-Performance matrix (IP matrix), is by plotting the performance of the organization for various dimensions against the importance of these factors regarding the customer's expectations. It is like a gap analysis between the expectations (and importance) and the actual performance. It is similar to the ServQual model, but it is a graphical representation. In addition to that, the

dimensions are placed in the IP matrix based on both customers' importance and companies' performance. Figure 2 shows the areas that a company is placing too much effort and resources ('Excess'), or doing almost nothing for them ('Urgent Action'). Also, it indicates where a factor is appropriate, and where it needs improvement.

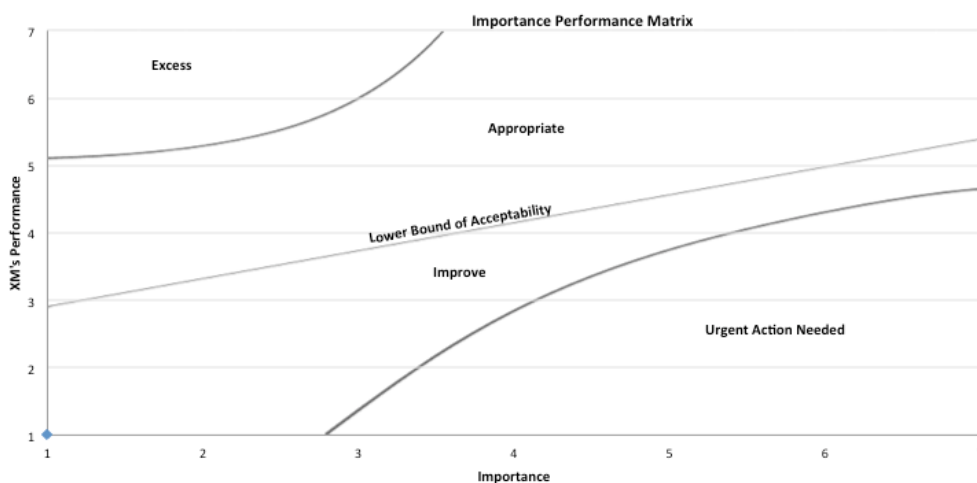

Figure 2 - Importance-Performance Matrix Template

ServQual (and IP Matrix) in combination with co-relations will indicate us the areas of improvement, and where the company should make immediate actions.

3.8 Ethical Considerations

XM, has strict policies governing the confidentiality of information related to their customers. In such organization everyone must follow values like trust, confidence, and privacy. In this study, the trust, privacy, and confidentiality values will be followed both internally, but also externally from other related parties, such as NUP.

For underlying reasons, the agreement of the management team was needed before any attempt to contact the customers. There were no statements used that exposed the identity of the participants.

In addition to this, the cover page of the survey presented the ethical approach of this research and the confidentiality and anonymity of participants.

4 Results Analysis

SurveyMonkey (“SurveyMonkey”, 2013), which was the tool used for creating and distributing the online questionnaires, provides export tools for data analysis. All the data were exported to SPSS (.sav) files and excel (.xls) files in order to help with the data analysis. SPSS was used to conduct reliability and factor analysis, as well as to calculate mean, to generate the correlations, and conduct the ServQual analysis. Excel was used in order to generate the graphs and some of the tables used. Moreover, SurveyMonkey by itself provides a text analysis, which can give valuable information on the qualitative analysis part. It provides with frequency of occurrence of various keywords used in the “more comments” field.

As mentioned in Sub-chapter **Error! Reference source not found.**, XM has a premium account at SurveyMonkey. This helps to overcome the limit of 100 responses and 10 questions per survey that the free (basic) package offers (https://www.surveymonkey.com/pricing/?ut_source=header).

4.1 Demographics

The total responses of the questionnaire were 687, but only 462 fully completed the questionnaire. All the questions were compulsory which lead to the conclusion that 225 of the participants quitted before they fully completed the questionnaire. For the purpose of this study, the 225 uncompleted questionnaires are fully excluded from the results analysis, which resulted in 462 total responses available for analysis.

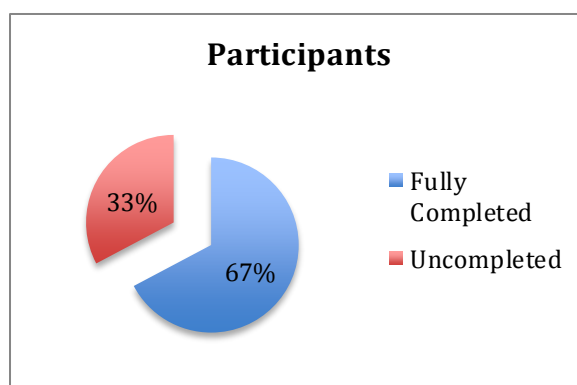

Figure 3 - Questionnaire Participants

For presentation purposes, the demographics are splintered into three parts. The first part contains general demographics such as gender, age, and education level. The second part

consists of countries. The reason that countries composed a whole demographic part is that there was a big variety of countries that cannot be easily presented with the rest of the results. Last, XM and trading specific demographics are shown. This category includes months that the participant is trading with XM, the account type, and account leverage.

4.2 General Demographics

The majority of the participants were male (93.7%) in contrast to only 6.3%, which were female. This is due to the fact that XM’s customer base is constituted of approximately 10% female. Consequently the low female responding percentage was expected.

Moreover, the age groups 21-29, 30-39, and 40-49 composed the 87% of the sample, while the other 13% was from less than 21 and more than 50. More analytically, 128 participants were in “21-29” age group, 170 participants were in the “30-39” age group, and 102 participants were in the “40-49” age group.

| Total Responses | | |
|--------------------|-----|-------|
| 462 | | |
| Gender | | |
| Male | 433 | 93.7% |
| Female | 29 | 6.3% |
| Age | | |
| 18-20 | 12 | 2.6% |
| 21-29 | 128 | 27.7% |
| 30-39 | 170 | 36.8% |
| 40-49 | 102 | 22.1% |
| 50-59 | 39 | 8.4% |
| 60+ | 11 | 2.4% |
| Level of Education | | |
| High School | 124 | 26.8% |
| Bachelor's Degree | 196 | 42.4% |
| Master's Degree | 94 | 20.3% |
| Doctorate | 15 | 3.2% |
| Other | 33 | 7.1% |

Table 5 - General Demographics

Last, the education level was concentrated in High School, Bachelor’s or Master’s Degree were they aggregate to 89.5%. Only a small portion belonged to Doctorate, or Others category (10.5% aggregate). More analytically, 26.8% hold a High School degree, 42.4% hold a Bachelor’s degree, and 20.3% hold a Master’s degree.

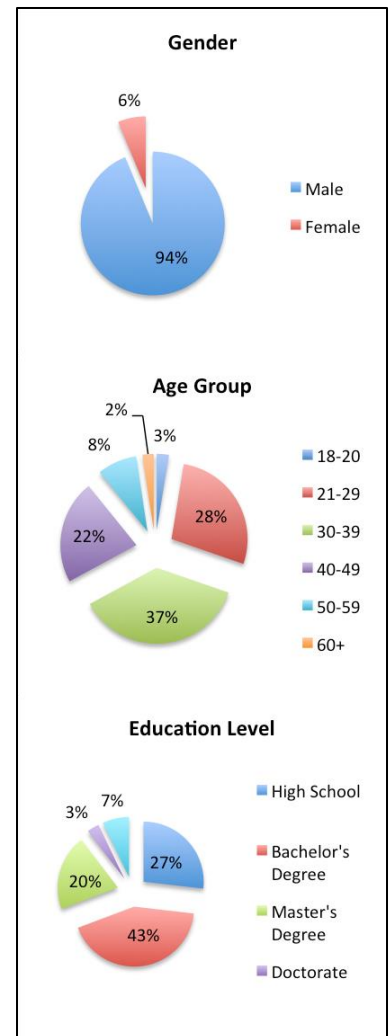

Figure 4 - General Demographics

4.2.1 Country Demographics

The respondents were spread among a wide variety of countries. To be more specific, this survey included participants from 81 countries. For illustration purposes, only countries more than 1.5% are presented in the Table 6 as any lower than that represent a tiny amount of sample. It can be seen that the top four countries are Asia countries, and then

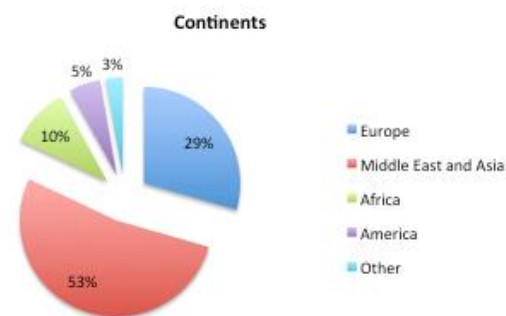

Figure 5 - Responses by Continent

Table 6 - Top Countries Demographics

| Total Responses | | |
|-----------------|----|-------|
| 462 | | |
| Country | | |
| Malaysia | 53 | 11.5% |
| Indonesia | 44 | 9.5% |
| Pakistan | 26 | 5.6% |
| India | 25 | 5.4% |
| Italy | 21 | 4.5% |
| Hungary | 19 | 4.1% |
| Nigeria | 16 | 3.5% |
| Bangladesh | 15 | 3.2% |
| Egypt | 10 | 2.2% |
| Greece | 10 | 2.2% |
| Saudi Arabia | 10 | 2.2% |
| Turkey | 10 | 2.2% |
| Brunei | 9 | 1.9% |
| Cyprus | 9 | 1.9% |
| Spain | 8 | 1.7% |
| UK | 8 | 1.7% |
| Germany | 8 | 1.7% |

everything follows. To illustrate the whole picture, the countries were splintered across continents, and presented in Figure 5. More analytical Asia countries represent 52.7%, Europe continent represent 29.47%, Africa represent 10.2%, America represent 5.2%, and “Others” represent 2.8% of our sample. To be more specific “Others” category includes Australia by 0.9%, Russia by 0.9%, and “not specified” by 1.1%. Russia was included in the “Others” category since a part of Russia is in the European continent, while the rest of Russia is in the Asia continent. It was decided that it does not worth to include Australia as a whole continent since it is a tiny percentage of our sample. Last, “not specified” was answers of non-countries. The country selection was not a drop down menu, but a text box. This allowed the participants to write anything, without any validation. This resulted in 1.1% (5 responses) of non-valid country, which was included in the “Others”.

4.3 XM-Specific Demographics

Some demographics were also collected that are related with XM and/or their trading account with XM. Those demographics included the months that the participant was trading with XM, their trading account type, and their trading account leverage.

As it can be seen from Table 7, the majority of the participants were new to XM (1-3 months 35.9%), and the percentage decreased, as the months of trading with XM got bigger.

Moreover, it can be seen that almost 2/3 of the participants hold a Micro Account, which means that they traded with less volume.

Last, trading account leverage can be seen that is concentrated on higher leverage (888,500, and 100). This can lead to the conclusion that the majority of the participants are more risk-taking.

Table 7 - XM/Trading Specific Demographics

| Total Responses | | |
|--------------------------|-----|-------|
| 462 | | |
| Months Trading with XM | | |
| 1-3 | 166 | 35.9% |
| 3-6 | 97 | 21.0% |
| 6-12 | 96 | 20.8% |
| 12-24 | 62 | 13.4% |
| 24+ | 41 | 8.9% |
| Trading Account Type | | |
| Micro | 291 | 63.0% |
| Standard | 171 | 37.0% |
| Trading Account Leverage | | |
| 1:888 | 178 | 38.5% |
| 1:500 | 103 | 22.3% |
| 1:400 | 32 | 6.9% |
| 1:300 | 7 | 1.5% |
| 1:200 | 40 | 8.7% |
| 1:100 | 73 | 15.8% |
| 1:66 | 1 | 0.2% |
| 1:50 | 8 | 1.7% |
| 1:25 | 3 | 0.6% |
| 1:15 | 1 | 0.2% |
| 1:10 | 5 | 1.1% |
| 1:5 | 1 | 0.2% |
| 1:3 | 0 | 0.0% |
| 1:2 | 0 | 0.0% |
| 1:1 | 10 | 2.2% |

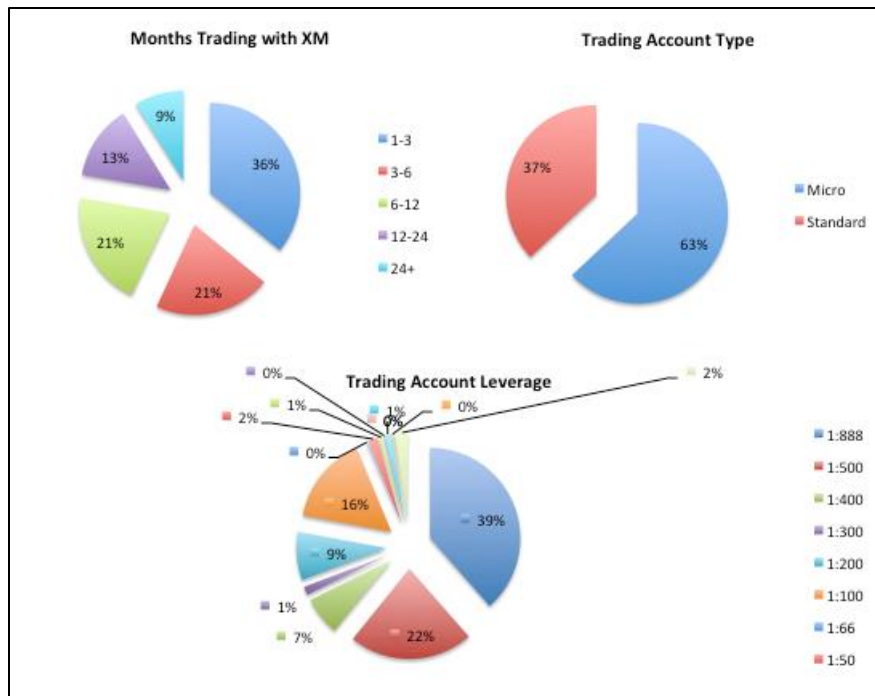

Figure 6 - XM/Trading Specific Demographics

4.4 Reliability, Factor analysis, and Sample Size

4.4.1 Sample Size Analysis

As mentioned in the previous sub-chapter, we ended up with 462 fully completed responses. This is much higher than the minimum requirement set back in chapter 3.4.1 (385 responses for a 95% probability that our answers will rely within $\pm 5\%$). From the amount of sample collected, we can conclude that we have excellent size of sample. The problem relies on the response rate. Since we send out 77,000 email questionnaires, and we collected 462, that means that we collected only 0.6%. In the literature, there are a lot of low response rates, such as 2% (Monroe and Adams, 2012). Since our response rate is too low, it runs the risk of having the “low-response rate” bias in our answers. Moreover, the low response rate can be justified since a lot of XM clients have duplicate emails, or a lot of XM clients stopped trading with XM for a long time ago. This means that email questionnaires sent out to duplicate contacts, or to people that doesn't have an interest anymore. All the above can justify the low response rate, along with lower response rates for email questionnaires recorded in the literature.

4.4.2 Factor and Reliability Analysis

4.4.2.1 Factor Analysis

Initially Factor Analysis was conducted. Questions were splintered into two halves, the first one is more related to traditional ServQual Dimensions (responsiveness, reliability, communication, and trust), and the second set of questions is more related with website dimensions (Website content and functionality, and Website Ease of Use). For both sets of questions two factors analysis were conducted, one for the “Importance” set of questions, and one for the “Performance” set of questions. Last, factor analysis of satisfaction questions was conducted too. This gives a total of five different factor analysis. The results of all five factor analysis can be fully seen in “Appendix D - Factor Analysis” and are summarized in Figure 7.

All the factors shows the validity of the dimensions of this study, and that the questions contribute successfully to the dimension propositioned by the literature. There were only two

problems spotted. Question 28 (both performance and importance) was removed from further analysis due to cross loading among all four factors.

Moreover, Question 36 was removed from “Website Ease of Use” and added to the dimension of “Website Content and Functionality”. The reason for that change is that Question 36 had negative or very low (below 0.1) factor analysis with the factor representing “Website Ease of Use”, in contrast with the high factor analysis score that question 36 had with the “Website Content and Functionality” (0.850 and above). For both the above reasons, the movement of that question to a different variable was justified.

4.4.2.2 Reliability Analysis

Since of the high scores of factor analysis, high scores in reliability analysis were expected. Reliability analysis was conducted in order to identify whether there is internal consistency. Moreover, Reliability analysis can help identify if the reliability of a variable can be improved by removing a question from a variable (if Cronbach’s α increases with deletion of a question, then it means that removing that question will lead to a more reliable variable).

In order to summarize all the factor and reliability analysis, Figure 7 shows all the final dimensions with their factor loadings and their Cronbach’s α score.

As it can be seen from Figure 7, factor analysis loadings are high enough, thus high reliability scores. According to Hair et al. (2011) Cronbach’s α score above 0.70 are satisfactory.

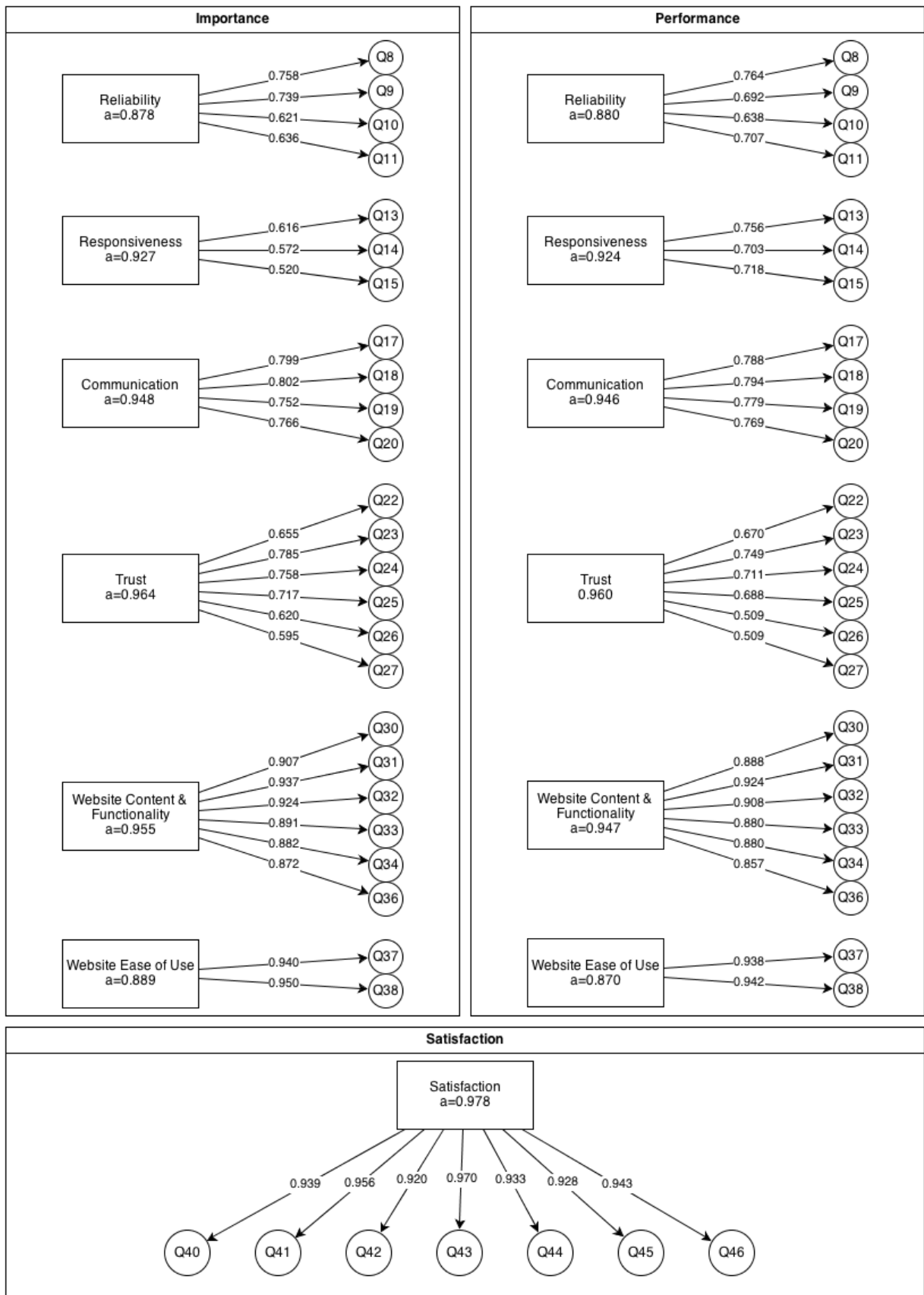

Figure 7 - Factor and Reliability Analysis

4.5 E-ServQual

According to “Appendix C – Coding Table”, the means of the 6 dimensions for both importance and performance were calculated. The means were calculated with SPSS “Descriptive Statistics” functionality. After all, the difference of the Performance and Importance was calculated. This difference indicates the ServQual score for each dimension. Table 8 summarizes and shows all the means for both importance and performance, as well as the ServQual score for each of the dimensions.

Table 8 - e-ServQual Results

| | Importance | Performance | ServQual (P-I) |
|--|-------------------|--------------------|-----------------------|
| Reliability | 5.881 | 5.7137 | -0.1673 |
| Responsiveness | 5.8564 | 5.6039 | -0.2525 |
| Communication | 5.7668 | 5.5703 | -0.1965 |
| Trust | 6.0162 | 5.7695 | -0.2467 |
| Web Content & Functionality | 5.7933 | 5.6259 | -0.1674 |
| Web Ease of Use | 4.092 | 4.3182 | 0.2262 |
| Satisfaction | 5.7378 | | |

As Table 8 shows, there is not any significant difference between performance and importance. In fact, in the case of “Web Ease of Use”, XM performs better than customer’s expectations. In the rest of the variables, XM performs insignificant lower (-0.2525 the worst case) than customer’s expectations.

Moreover, for a better visualization of the variables, Figure 8 shows an Importance-Performance matrix of the variables. All variables are above the “Lower Bound of Acceptability” line, which means that XM performs at appropriate levels for all the variables. Moreover, none of the dimensions are in the area of “Excess”, which means that there is no over performance in any of the dimensions unnecessary.

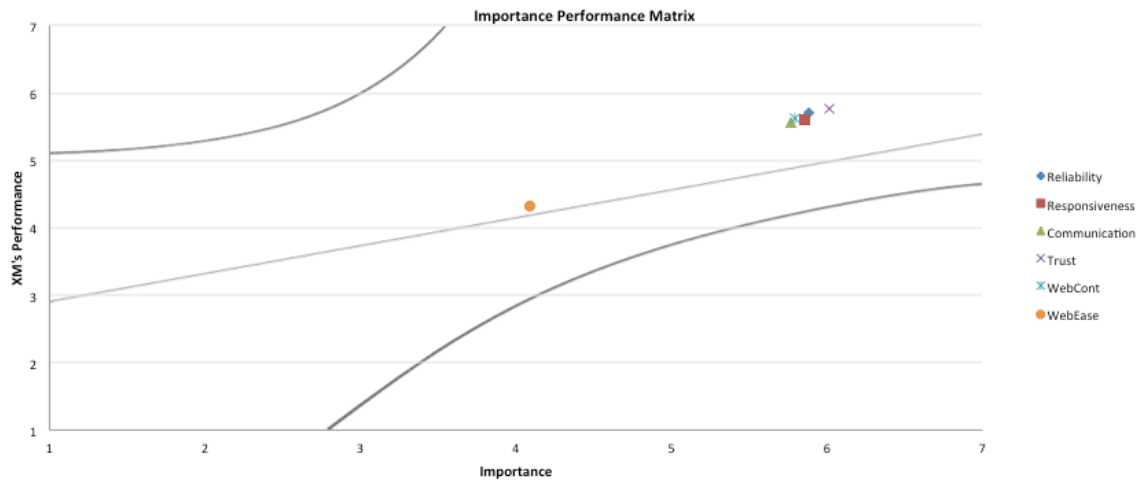

Figure 8 - Importance Performance Matrix

Last, Figure 9 shows another graphical representation of the importance and performance of the dimensions. It can be easily seen that in all dimensions the performance is slightly lower than the performance, except in the “Web Ease of Use”. Moreover, Figure 9 shows that all dimensions are highly important, except the “Web Ease of Use” which shows a significant lower importance (and performance) than the other dimensions.

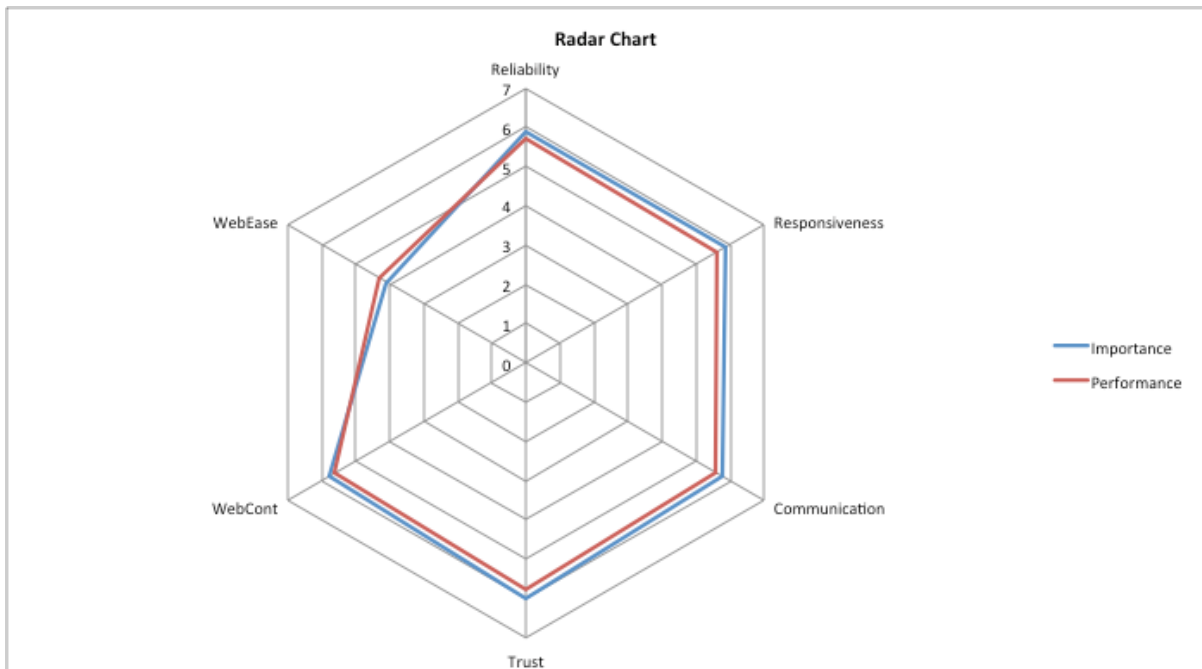

Figure 9 - Radar Chart

4.6 Correlations – Satisfaction

Correlations were conducted for all importance variables (Table 9), and for all performance variables along with the client’s satisfaction (Table 10). Correlations will show whether there is any relation between the variables.

Table 9 - Importance Correlation

| Importance | Mean | S.D. | (01) | (02) | (03) | (04) | (05) | (06) |
|--|------|------|--------|--------|--------|--------|--------|------|
| Reliability (01) | 5,88 | 1,34 | 1 | | | | | |
| Responsiveness (02) | 5,86 | 1,50 | 0,832 | 1 | | | | |
| Communication (03) | 5,77 | 1,49 | 0,731 | 0,836 | 1 | | | |
| Trust (04) | 6,02 | 1,36 | 0,804 | 0,788 | 0,813 | 1 | | |
| Website Content and Functionality (05) | 5,79 | 1,38 | 0,764 | 0,747 | 0,765 | 0,806 | 1 | |
| Website Ease of Use (06) | 4,09 | 2,13 | -0,047 | -0,069 | -0,081 | -0,141 | -0,165 | 1 |

| |
|---|
| Notes: |
| Orange Color = p<0.01 (Correlation is significant) Green Color = Not correlated N=462 |

As it can be seen from Table 9 (Importance only correlations), “Reliability” is highly correlated (above 0.731) with all the variables except “Website Ease of Use”. The same pattern exists with all other variables. In more details, all variables are correlated at the significant level of 0.01 with all variables, with minimum “Pearson Correlation” of 0.731 and maximum of 0.836. The only variable that is not correlated with any other variable is the “Website Ease of Use”.

Table 10 - Performance and Satisfaction Correlation Table

| Performance | Mean | S.D. | (01) | (02) | (03) | (04) | (05) | (06) | (07) |
|--|------|------|--------|--------|--------|--------|--------|--------|------|
| Reliability (01) | 5,71 | 1,35 | 1 | | | | | | |
| Responsiveness (02) | 5,60 | 1,59 | 0,782 | 1 | | | | | |
| Communication (03) | 5,57 | 1,56 | 0,711 | 0,86 | 1 | | | | |
| Trust (04) | 5,77 | 1,42 | 0,8 | 0,756 | 0,798 | 1 | | | |
| Website Content and Functionality (05) | 5,63 | 1,39 | 0,767 | 0,741 | 0,749 | 0,818 | 1 | | |
| Website Ease of Use (06) | 4,32 | 2,05 | -0,024 | -0,019 | -0,012 | -0,042 | -0,074 | 1 | |
| Satisfaction (07) | 5,74 | 1,47 | 0,732 | 0,684 | 0,703 | 0,83 | 0,753 | -0,054 | 1 |

| |
|---|
| Notes: |
| Orange Color = p<0.01 (Correlation is significant) Green Color = Not correlated N=462 |

Moreover, Table 10 shows the Performance and Satisfaction correlations. The performance variables follow exactly the same pattern as the “Importance” correlation. In more details, all performance variables are highly correlated in the significance of 0.01 level. The lowest

correlation is 0.711 and the highest is at 0.860. The only variable that is not correlated is the “Website Ease of Use”.

In Table 10 we can also see the correlation of the client’s satisfaction with the rest of the variables. This correlation is highly important since it shows which variables are most important, and contribute more to the overall client satisfaction. All the Performance variables are positive and highly correlated in 0.01 significant level with the satisfaction except “Website Ease of Use”. More specifically, the “Trust” is the highest correlated with Pearson correlation score of 0.830. Reliability, Communication, and Website Content and Functionality follow with correlations in the range of 0.700-0.800. The least correlated, but still significant, is the Responsiveness, which is correlated at 0.684 level.

4.7 Text Analysis

Survey monkey provides a tool for analyzing text, and generating frequent word usage. The main purpose of this study is to quantitatively analyze the data. This Qualitative part is briefly analyzed, and the analysis took place is very generic.

Survey monkey provides the most frequent words used per variable. These words can be positive, negative, mixed, or not related. Since the client writes these words, it was assumed that the client considers them as important. For example, a client that is very happy, he/she will write a positive comment about the most important part for himself. For example “very good, fast live chat support” is a positive comment, and the client gives emphasis on live chat support which we assume that he/she believe that is important. On the other hand, if a client is disappointed, he/she will still mention something important. For example “XM's trading platform is not working well. It shows older data market”. In that example, the client leaves a negative comment, and gives emphasis on the trading platform, which we assume that he/she believes that it is important.

The entire text analysis was based on the assumption that a customer mentioned a word that he/she believes that is important. So, the text analysis will help identify what is important, and what not for a customer.

Figure 10 shows the summary of all the comments of the variables. On the “Reliability” variable, “Trading” is the most used word, counting 14% of the responses. Moreover, “Broker”, “Platform”, and “Account” are mentioned in 8% of the responses. In the same matter, Figure 10 shows all the frequently used words, of all the comments, of all variables. While a lot of them are not conclusive, it was seen that “Trading” is the first, or at least in the top 10 used words of almost all variables. Moreover, “Withdrawal” and “Money” are the most frequent words in the dimension of “Trust”.

Although not all of the words make sense, text analysis will be a complimentary supply to the quantitative part of this survey.

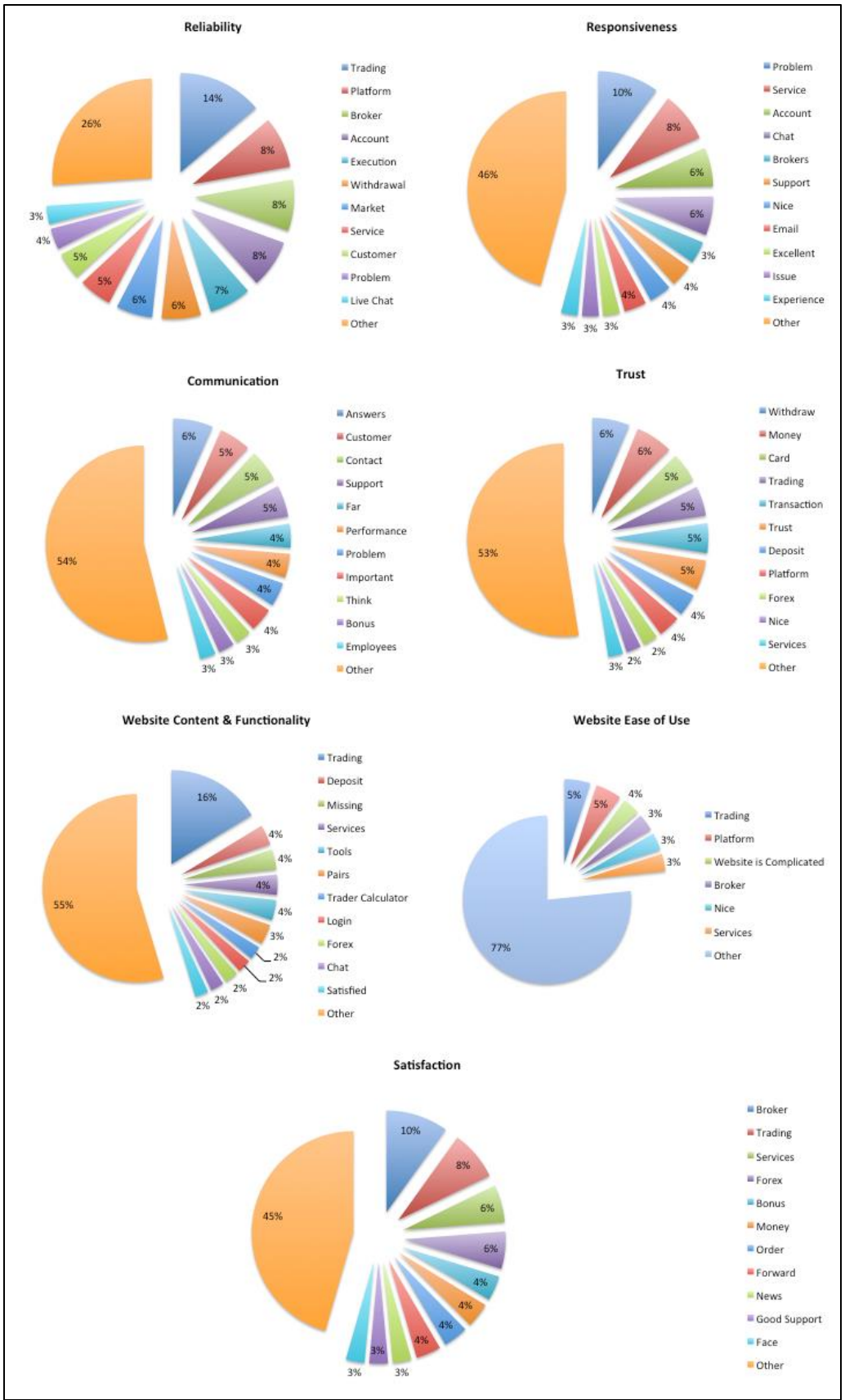

Figure 10 - Text Analysis

Page intentionally left blank

5 Discussion

As it can be seen from Table 8, XM's ServQual scores were a number near 0. That indicated that the customers received the service that they expect. In one of the dimensions (Website Ease of Use), customers received better service than the expected one. According to these results, XM's service quality is near customer's expectation. This can also be confirmed by considering the importance-performance matrix (Figure 2 & Figure 8), which shows all the dimensions in the "Appropriate" region.

According to the aforementioned results, XM is near perfection and should retain its current service quality. This statement is half true if we consider the turbulent environment of today's competition. In order to survive in this competitive world, XM should continue to improve. According to Khan (2011), continuous improvement, or Kaizen, is one of the main reasons of Japanese competitive success. Kaizen is a concept created by Dr. W. Edwards Deming, and is a process that includes continuous improvement through small steps to achieve a better product, process, or service (Suárez-barraza, 1995).

Since ServQual model showed that XM's service quality is at appropriate levels, and considering Kaizen, the next steps are to identify the key areas where XM should excel in order to gain competitive advantage from the competition. There are two ways to identify those dimensions; firstly from the customer's answers on the "importance" part of the question and secondly, from the correlation of the dimensions through the customer satisfaction variable.

From Table 8 (which shows the mean values of each dimension for both importance and performance), if the "importance" part of the dimensions is isolated the importance that customers are giving to each dimension is clear. If these results get sorted, then the following table (Table 11) can be created.

Table 11 - Importance of ServQual dimensions based on customer responses

| | Importance based on customer responses |
|--|---|
| Trust | 6,0162 |
| Reliability | 5,881 |
| Responsiveness | 5,8564 |
| Web Content & Functionality | 5,7933 |
| Communication | 5,7668 |
| Web Ease of Use | 4,092 |

Moreover, the importance of each dimension can be derived from the correlation of “Customer Satisfaction” and the Service Quality dimensions (Table 10). If the dimensions based on the highest correlation get sorted with “Customer Satisfaction” the following table is derived (Table 12):

Table 12 - Importance of ServQual dimensions based on correlation with Customer Satisfaction

| | Importance based on correlation with satisfaction |
|--|--|
| Trust | 0.83 |
| Web Content & Functionality | 0.753 |
| Reliability | 0.732 |
| Communication | 0.703 |
| Responsiveness | 0.684 |
| Web Ease of Use | -0.054 |

To summarize, Table 11 shows the ServQual dimensions and their importance according to customer responses on questions of the “importance” part of the ServQual model, and Table 12 shows the correlation of customer satisfaction with the “performance” part of the ServQual model.

As it can be seen from both tables, “Trust” is the most important dimension with the biggest difference among the others. A study conducted by Lee and Lin (2005) concluded with similar results. Lee and Lin (2005) conducted an E-ServQual for e-commerce. The main target was to relate purchase intentions with customer satisfaction and overall service quality, and with E-ServQual dimensions. The ServQual dimensions used in his study was Website design, Reliability, Responsiveness, Trust, and Personalization. Lee and Lin (2005) wanted to correlate those dimensions with Overall service quality, customer satisfaction, and purchase intention. The results of the survey showed that Trust was the highest correlated dimension with both Overall Service Quality and Customer Satisfaction. Overall Service Quality and Customer

satisfaction are both related to Purchase Intention, thus Trust is the strongest dimension regarding "Purchase Intention" (Lee and Lin, 2005, p.170-173). Lee and Lin (2005) is not the only research that supports this argument. Gefen (2000) also proved that Trust is one of the most-contributing dimensions to purchase intention. Gefen's (2000) study wasn't a ServQual, but a correlation of various dimensions with purchase intention. Those are not the only studies that have proven that trust is one of the most important dimension is service quality, Mani et al. (2003) Wolfinbarger and Gilly (2003) are some other cases that support this argument. Trust can be considered the dimension with the highest correlation with customer satisfaction since this study, other ServQual studies, and other non-related studies prove the same result.

Except the Trust dimension, Table 11 and Table 12 shows that Reliability, Responsiveness, Website content and functionality, and Communication are all related to customer satisfaction, and are ranked high on the importance scale of clients. For these dimensions, there was not any consistent ranking between the two evaluation methods used (correlation with satisfaction and selection of importance by participants), but in both cases, all those dimensions are close in importance from one to another.

These results are also supported by numerous other studies. For example, Mani et al. (2003) conducted a ServQual on virtual community websites, and proved that Reliability, Tangibles (comparable to website content and functionality & website ease of use), Assurance (comparable to Trust dimension), Responsiveness and Empathy (comparable to Communication) are all important for a service quality model, and all contributes to Overall Service quality, overall satisfaction, continuous usage, Loyalty, frequency of use, and recommending the website to other users. Mani et al. (2003) also provide a ranking of these variables based on their importance. The most important variable based on Mani et al. (2003) study was Reliability followed by: Tangibles, Assurance, Responsiveness, and last Empathy.

Yang et al. (2004) is another study correlating the aforementioned variables with overall satisfaction and overall service quality. One notable difference is that his study included website ease of use. In this study, Website ease of use is not correlated, and not selected as importance among the participants. In contrast, Yang's et al. (2004) study, website ease of use is highly correlated with both service quality and customer satisfaction. This study also conflicts with the

findings of Rice (1997). Rice (1997) published an article proving that website ease of use is one of the factors that makes users to repeat a visit to a website, thus related to purchase intention.

Since the different results of this study and the literature exist, further discussion for Website Ease of use is required. Website Ease of Use dimension was the only dimension that had negatively worded questions. Web Ease of Use dimensions was composed of three questions 36, 37, and 38 (See Appendix A – Traditional ServQual Questionnaire). Question 36 had a positive meaning, and question 37 and 38 has a negative meaning. Question 36 was removed from Website Ease of Use, and was added to the dimension of Website Content and Functionality (See subchapter 4.4.2.1). Question 37 and question 38 were the remaining questions, both negative, that represent the dimension of website ease of use. According to Colosi (2000), negatively worded questions might cause confusion of the participants. This will lead to errors associated with the responses. More specifically, Colosi (2000) found that 8% of respondents answer inconsistently if the questionnaire includes negative questions, as opposed to 2.56% with the positive worded questions.

Taking into consideration the above study, even if the results of this study showed no correlation with the website ease of use, XM should consider it as one of the dimensions that contributes to repeated website visits (Rice, 1997) and customer satisfaction (Yang et al., 2004).

If we exclude the website ease of use dimension because of the possibility of error, as of Table 9 and Table 10 (correlation table) all dimensions are correlated with each other. This means that if one of them is improved, then other dimensions are improved as well. For example, if XM improves website content and functionality, then at the same time Trust, Communication, Responsiveness, and Reliability will be improved because they are highly positive correlated. Yang et al. (2004) study found high positive correlation between the dimensions as well. Yang et al. (2004) commented that because of the inter-correlation, it is vital to maintain a balance service quality between all dimensions, which will lead to overall customer satisfaction.

To conclude, this study provided us with the ServQual of XM, and showed that no problems exist. However, considering the high competitive environment of retail Forex companies, continuous improvement is a vital philosophy to follow. In order to improve, XM should pay additional attention to Trust, because it is the most important dimension that contributes to customer satisfaction. Moreover, XM should try to improve all other dimensions because they

are correlated with each other, and a balance improvement among all dimensions is needed in order to improve the overall customer satisfaction.

Page intentionally left blank

6 Conclusion and Final Thoughts

6.1 Achievements

Based on chapter 1.2, all the aims and objectives of this study are fulfilled. More specifically the objectives fulfilled during this project are:

- Identification of best model to measure the service quality of XM
- A questionnaire was prepared in order to explain customer satisfaction and to measure service quality of XM
- Validate the dimensions and the questionnaire
- ServQual was conducted and analyzed
- Identification of the most crucial dimension that contributes more to customer satisfaction
- Present general improvements that XM should undertake

The above set of achieved objectives, allowed to accomplish the aims of this project. More specifically, the overall service quality of XM was assessed, and the key dimensions that XM should excel in order to gain competitive advantage were identified.

6.2 Limitations and Further work

Through this study, some problems and limitations occurred. Firstly, the response rate was very low, which might indicate biased responses. A possible solution for future work is to resubmit the questionnaire to a more targeted audience. Secondly, there was a problem, as mentioned in the discussion, with the “website ease of use” dimensions. A possible problem, also discussed in discussion chapter, is to use only positive questions. For future work, a possible solution to this problem is to re-submit the questionnaire with only positive questions. Moreover, text analysis was very basic, and through a further analysis, deeper knowledge might be acquired.

Furthermore, additional dimensions might be helpful to address more aspect of XM business. Last, the questionnaire was in English, and many of the participant's native language is not English. In further research, translation of the questionnaire is recommended.

Another important possible limitation of this study is the length of the questionnaire. There is always the possibility that a participant went through the questionnaire without reading the questions, and thus giving us the perfect picture of the perfect company. Further validation of the questionnaire may be addressed, and conduct further analysis for the validity of the responses.

6.3 Conclusion

This study successfully identifies and “quantifies” the service quality of XM. Though XM service quality results were positive, and met all customer expectations, this study helped in identifying the key dimensions that are critical to customer satisfaction. More specifically, “trust” dimension was proven to be the most important one, no wonder, since customers trust their money in a non-tangible company, where online services are the only product offered.

Through this project, a hybrid ServQual model was created and validated, which allows ServQual model to be applied to online retail financial institutions. It is a proven and validated model, which can be reused for further studies. “Hybrid” is a term used to describe the fact that ServQual dimensions were composed among the literature of various studies, but also “hybrid” is used in order to describe the combination of ServQual model with customer satisfaction. The customer satisfaction variable correlated with ServQual dimensions can help in better identifying key dimensions in an online financial institution.

7 References

- Alanezi, M.A., Kamil, A. and Basri, S. (2010), "A proposed instrument dimensions for measuring e-government service quality", *International Journal of u- and e- Service, Science and Technology*, Vol. 3 No. 4, pp. 1–18.
- Anderson, D.R., Sweeney, D.J. and Williams, T.A. (2010), *Statistics for Business and Economics, Chemistry & biodiversity*, South-Western Pub, Vol. 1, pp. 1829–1841.
- Belanger, F., Hiller, J.S. and Smith, W.J. (2002), "Trustworthiness in electronic commerce: the role of privacy, security, and site attributes", *The Journal of Strategic Information Systems*, Vol. 11 No. 3-4, pp. 245–270.
- Buttle, F. (1996), "SERVQUAL: review, critique, research agenda", *European Journal of Marketing*, Vol. 30 No. 1, pp. 8–32.
- Carman, J.M. (1990), "Consumer perceptions of service quality: An assessment of the SERVQUAL dimensions.", *Journal of Retailing*, Vol. 66 No. 1, pp. 33–55.
- Chisnall, P.M. (2004), *Marketing Research*, McGraw-Hill Higher Education, p. 496.
- Cho, N. and Park, S. (2001), "Development of electronic commerce user-consumer satisfaction index (ECUSI) for Internet shopping", *Industrial Management & Data Systems*, MCB UP Ltd, Vol. 101 No. 8, pp. 400–406.
- Colosi, R. (2000), "Negatively Worded Questions Cause Respondent Confusion ?", *Survey Research Methods*, Vol. 20746, pp. 2896–2903.
- Cronin, J.J. and Taylor, S.A. (1992), "Measuring Service Quality : A Reexamination and Extension", *Journal of Marketing*, Vol. 56 No. July, pp. 55–68.
- Cronin, J.J. and Taylor, S.A. (1994), "SERVPERF Versus SERVQUAL: Reconciling Performance-Based and Measurement of Service Quality", *Journal of Marketing*, Vol. 58 No. January, pp. 125–132.

- Crosby, P. (1995), *Quality Without Tears: The Art of Hassle-Free Management*, McGraw-Hill, p. 205.
- Deming, W.E. (2000), *Out of the Crisis*, The MIT Press, p. 507.
- Durvasula S, L.A.C. (2004), "Cruising along: the impact of service quality in the cruise liner industry", *Asian Journal of Marketing*, Vol. 10 No. 1, available at: http://www.researchgate.net/publication/235779519_Cruising_along_the_impact_of_service_quality_in_the_cruise_liner_industry (accessed 8 September 2013).
- Van Dyke, T.P., Kappelman, L.A. and Prybutok, V.R. (1997), "Measuring Information Systems Service Quality: Concerns on the Use of the SERVQUAL Questionnaire ^ The SERVQUAL Instrument .:", *MIS Quarterly*, Vol. 195-208 No. June, pp. 195–20.
- Feigenbaum, A. V. (2004), *Total Quality Control 4th edition*, McGraw-Hill Professional, p. 896.
- Finn, D.W. and Lamb, C.W. (1991), "An Evaluation of the Servqual Scales in a Retailing Setting", *Advances in Consumer Research*, Vol. 18, pp. 483–490.
- Gefen, D. (2000), "E-commerce: the role of familiarity and trust", *Omega*, Vol. 28 No. 6, pp. 725–737.
- Hair, J.F., Ringle, C.M. and Sarstedt, M. (2011), "PLS-SEM: Indeed a Silver Bullet", *The Journal of Marketing Theory and Practice*, Vol. 19 No. 2, pp. 139–152.
- Ishikawa, K. (1988), *What is Total Quality Control? the Japanese Way*, Prentice Hall, p. 240.
- Iwaarden, J. Van, Wiele, T. Van Der, Ball, L. and Millen, R. (2003), "Applying SERVQUAL to Web sites: an exploratory study", *International Journal of Quality & Reliability Management*, Vol. 20 No. 8, pp. 919–935.
- Jill Z. (2011), "How Many Days Does it Take for Respondents to Respond to Your Survey? | SurveyMonkey Blog", available at:

<https://www.surveymonkey.com/blog/en/blog/2011/06/08/time-to-respond/> (accessed 4 June 2014).

Juran, J.M. and Godfrey, A.B. (1998), *Jurans Quality Handbook*, (Hoogstoel, R.E. and Schilling, E.G.,Eds.), McGraw-Hill, 5thed.

Khan, I.A. (2011), “KAIZEN : The Japanese Strategy for”, Vol. 1 No. 3, pp. 177–184.

Kong, T.H., Hom, H. and Kong, H. (2004), “Customer Satisfaction , Service Quality Jackie L. M . Tami and Perceived Value : An Integrative Model”, *Journal of Marketing Management*, Vol. 20, pp. 897–917.

Kothari, C.R. (2004), *Research Methodology: Methods and Techniques*, New Age International, p. 401.

Lee, G.-G. and Lin, H.-F. (2005), “Customer perceptions of e-service quality in online shopping”, *International Journal of Retail & Distribution Management*, Vol. 33 No. 2, pp. 161–176.

Li, H. and Suomi, R. (2009), “A Proposed Scale for Measuring E-service Quality”, *International Journal of u- and e- Service, Science and Technology*, Vol. 2 No. 1, pp. 1–10.

Mani, T.P., Murugan, N. and Rajendran, C. (2003), “TQM is a must for success, but not sufficient for survival: A conceptual framework as contemplated in ancient Tamil literature in India”, *Total Quality Management & Business Excellence*, Vol. 14 No. 4, pp. 395–405.

Monroe, M.C. and Adams, D.C. (2012), “Increasing Response Rates to Web-Based Surveys”, *Journal of Extension*, Vol. 50 No. 6, available at: <http://www.joe.org/joe/2012december/tt7.php> (accessed 25 September 2013).

Page, C. and Lepkowska-White, E. (2002), “Web equity: a framework for building consumer value in online companies”, *Journal of Consumer Marketing*, MCB UP Ltd, Vol. 19 No. 3, pp. 231–248.

- Parasuraman, a. (2005), "E-S-QUAL: A Multiple-Item Scale for Assessing Electronic Service Quality", *Journal of Service Research*, Vol. 7 No. 3, pp. 213–233.
- Parasuraman, A., Berry, L.L. and Zeithaml, V.A. (1991), "Perceived Service Quality as a Customer-Based Performance Measure: An Empirical Examination of Organizational Barriers Using an Extended Service Quality Model", *Human Resource Management*, Vol. 30 No. 3, pp. 335–364.
- Parasuraman, A., Zeithaml, A.V. and Berry, L.L. (1985), "A conceptual model of service quality and its implications for future research", *Journal of Marketing*, Vol. 49, pp. 41–50.
- Parasuraman, A., Zeithaml, V.A. and Berry, L.L. (1994), "Reassessment of expectations as a comparison standard in measuring service qu ...", *Journal of Marketing*, Vol. 58 No. 1, pp. 111–124.
- Parasuraman, A., Zeithaml, V.A. and Berry, L.L. (1988), "SERVQUAL: A Multiple-Item Scale for Measuring Consumer Perceptions of Service Quality", *Journal of Retailing*, Vol. 64 No. 1.
- Pitt, L.F., Watson, R.T. and Kavan, C.B. (1997), "Measuring Information Systems Service Quality: Concerns for a Complete Canvas ^", *MIS Quarterly*, No. June, pp. 209–222.
- Pizam, A. and Ellis, T. (1999), "Customer satisfaction and its measurement in hospitality enterprises", *International Journal of Contemporary Hospitality Management*, MCB UP Ltd, Vol. 11 No. 7, pp. 326–339.
- Rice, B.M. (1997), "WE WEAR MANY What makes users revisit a Web site?", p. 12.
- Roca, J.C., García, J.J. and Vega, J.J.D. La. (2009), "The importance of perceived trust, security and privacy in online trading systems", *Information Management & Computer Security*, Vol. 17 No. 2, pp. 96–113.
- Saunders, M., Lewis, P. and Thornhill, A. (2009), *Research methods for business students*, Pearson Education, fifth edit.

- Smith, J.K. (1983), "Quantitative Versus Qualitative Research: An Attempt to Clarify the Issue", *Educational Researcher*, Vol. 12 No. 3, pp. 6–13.
- Sohn, C. and Tadisina, S.K. (2008), "Development of e-service quality measure for internet-based financial institutions", *Total Quality Management & Business Excellence*, Vol. 19 No. 9, pp. 903–918.
- Suárez-barraza, M.F. (1995), "Kaizen within Kaizen Teams: Continuous and Process Improvements in a Spanish municipality", No. 1986.
- "SurveyMonkey". (2013), , available at: <http://www.surveymonkey.com/> (accessed 15 May 2013).
- Taguchi, G. (1986), *Introduction to Quality Engineering: Designing Quality into Products and Processes*, Quality Resources, p. 191.
- Trudie, O., Reed, K., Rock, L. and Wigand, R.T. (2009), "MEASURING THE QUALITY OF E-SERVICE: SCALE DEVELOPMENT AND INITIAL VALIDATION", *Journal of Electronic Commerce Research*, Vol. 10 No. 1, pp. 13–28.
- Tse, D.K. and Wilton, P.C. (1988), "Models of Consumer Satisfaction Formation: An Extension", *Journal of Marketing Research*, Vol. XXV No. May, pp. 204–213.
- Udo, G.J. (2001), "Privacy and security concerns as major barriers for e-commerce: a survey study", *Information Management & Computer Security*, Vol. 9 No. 4, pp. 165–174.
- Wolfenbarger, M. and Gilly, M.C. (2003), "eTailQ: dimensionalizing, measuring and predicting etail quality", *Journal of Retailing*, Vol. 79 No. 3, pp. 183–198.
- "XM Account Leverage". (2013), , available at: <http://www.xm.com/margin-and-leverage> (accessed 29 September 2013).
- "XM Account Types". (2013), , available at: <http://www.xm.com/account-types> (accessed 29 September 2013).

- Yang, Z. and Fang, X. (2004), "Online service quality dimensions and their relationships with satisfaction: A content analysis of customer reviews of securities brokerage services", *International Journal of Service Industry Management*, Vol. 15 No. 3, pp. 302–326.
- Yang, Z., Jun, M. and Peterson, R.T. (2004), "Measuring customer perceived online service quality: Scale development and managerial implications", *International Journal of Operations & Production Management*, Vol. 24 No. 11, pp. 1149–1174.
- Yin, R.K. (1994), *Case Study Research: Design and Methods (Applied Social Research Methods)*, SAGE Publications, Inc, p. 192.
- Zeithaml, V.A. (1981), "How consumer evaluation processes differ between goods and services", *Marketing of Services*, pp. 186–190.
- Zikmund, W.G. (2003), *Business research methods*, Thomson/South-Western, p. 748.

8 Appendices

8.1 Appendix A – Traditional ServQual Questionnaire

DIRECTIONS: This survey deals with your opinions of _____ services. Please show the extent to which you think firms offering _____ services should possess the features described by each statement. Do this by picking one of the seven numbers next to each statement. If you strongly agree that these firms should possess a feature, circle the number 7. If you strongly disagree that these firms should possess a feature, circle 1. If your feelings are not strong, circle one of the numbers in the middle. There are no right or wrong answers. All we are interested in is a number that best shows your expectations about firms offering _____ services.

- E1. They should have up-to-date equipment.
- E2. Their physical facilities should be visually appealing.
- E3. Their employees should be well dressed and appear neat.
- E4. The appearance of the physical facilities of these firms should be in keeping with the type of services provided.
- E5. When these firms promise to do something by a certain time, they should do so.
- E6. When customers have problems, these firms should be sympathetic and reassuring.
- E7. These firms should be dependable.
- E8. They should provide their services at the time they promise to do so.
- E9. They should keep their records accurately.

- E10. They shouldn't be expected to tell customers exactly when services will be performed.
(-)
- E11. It is not realistic for customers to expect prompt service from employees of these firms.
(-)
- E12. Their employees don't always have to be willing to help customers. (-)
- E13. It is okay if they are too busy to respond to customer requests promptly. (-)
- E14. Customers should be able to trust employees of these firms.
- E15. Customers should be able to feel safe in their transactions with these firms' employees.
- E16. Their employees should be polite.
- E17. Their employees should get adequate support from these firms to do their jobs well.
- E18. These firms should not be expected to give customers individual attention. (-)
- E19. Employees of these firms cannot be expected to give customers personal attention. (-)
- E20. It is unrealistic to expect employees to know what the needs of their customers are. (-)
- E21. It is unrealistic to expect these firms to have their customers' best interests at heart. (-)
- E22. They shouldn't be expected to have operating hours convenient to all their customers. (-
)

DIRECTIONS: The following set of statements relate to your feelings about XYZ. For each statement, please show the extent to which you believe XYZ has the feature described by the statement. Once again, circling a 7 means that you strongly agree that XYZ has that feature, and circling a 1 means that you strongly disagree. You may circle any of the numbers in the middle that show how strong your feelings are. There are no right or wrong answers. All we are interested in is a number that best shows your perceptions about XYZ.

- P1. XYZ has up-to-date equipment.
- P2. XYZ's physical facilities are visually appealing.
- P3. XYZ's employees are well dressed and appear neat.
- P4. The appearance of the physical facilities of XYZ is in keeping with the type of services provided.
- P5. When XYZ promises to do something by a certain time, it does so.
- P6. When you have problems, XYZ is sympathetic and reassuring.
- P7. XYZ is dependable.
- P8. XYZ provides its services at the time it promises to do so.
- P9. XYZ keeps its records accurately.
- P10. XYZ does not tell customers exactly when services will be performed. (-)
- P11. You do not receive prompt service from XYZ's employees. (-)
- P12. Employees of XYZ are not always willing to help customers. (-)
- P13. Employees of XYZ are too busy to respond to customer requests promptly. (-)
- P14. You can trust employees of XYZ.
- P15. You feel safe in your transactions with XYZ's employees.
- P16. Employees of XYZ are polite.
- P17. Employees get adequate support from XYZ to do their jobs well.
- P18. XYZ does not give you individual attention. (-)
- P19. Employees of XYZ do not give you personal attention. (-)

P20. Employees of XYZ do not know what your needs are. (-)

P21. XYZ does not have your best interests at heart. (-)

P22. XYZ does not have operating hours convenient to all their customers. (-)

8.2 Appendix B – e-ServQual Questionnaire

XM.COM Service Quality

Questionnaire Information

This questionnaire is part of a research project being undertaken by Vasilis Hadjisophocle as a researcher and supervised by Dr. John Politis (Associate Professor in Business and Marketing at Neapolis University, Pafos). The purpose of this research is to identify gaps between expected and perceived service quality, and to related them with customer satisfaction.

The participation is entirely voluntary and you are not required to identify yourself in any way. Your answers will be confidential and it goes without saying that under no circumstances will your individual honest response be identified and/or made available to anyone in the company (employees and/or management). The questionnaire will be taken back to University for analysis and is strictly carried out for sole purpose of my MBA at Neapolis University. Aggregated results might be used for research purposes and may be reported to scientific/academic journals.

XM.COM Service Quality

Demographics

The following is requested so that meaningful analysis and comparisons of group results can be made. Your cooperation in completing this information will make the results of the survey more useful and beneficial. Please select

***1. Are you male or female?**

- Male
 Female

***2. Which category below includes your age?**

- 18-20
 21-29
 30-39
 40-49
 50-59
 60 or older

***3. Which country do you currently live in?**

Country:

***4. How many months are you trading with XM?**

- 1-3
 3-6
 6-12
 12-24
 24+

***5. What is the highest level of education you have completed?**

- High School
 Bachelor's Degree
 Master's Degree
 Doctorate
 Other

***6. What is your account type (registered with XM)**

- Micro
 Standard

***7. What is your Leverage?**

XM.COM Service Quality

Reliability

Instructions: The following statements are related with reliability. For each question please select how important it is for you, and how XM performs at that particular field.

*8. XM's trading platform is always working well

| | 1 - Strongly Disagree | 2 | 3 | 4 | 5 | 6 | 7 - Strongly Agree |
|------------------|-----------------------|-----------------------|-----------------------|-----------------------|-----------------------|-----------------------|-----------------------|
| Importance | <input type="radio"/> | <input type="radio"/> | <input type="radio"/> | <input type="radio"/> | <input type="radio"/> | <input type="radio"/> | <input type="radio"/> |
| XM's Performance | <input type="radio"/> | <input type="radio"/> | <input type="radio"/> | <input type="radio"/> | <input type="radio"/> | <input type="radio"/> | <input type="radio"/> |

*9. XM's website is always working well

| | 1 - Strongly Disagree | 2 | 3 | 4 | 5 | 6 | 7 - Strongly Agree |
|------------------|-----------------------|-----------------------|-----------------------|-----------------------|-----------------------|-----------------------|-----------------------|
| Importance | <input type="radio"/> | <input type="radio"/> | <input type="radio"/> | <input type="radio"/> | <input type="radio"/> | <input type="radio"/> | <input type="radio"/> |
| XM's Performance | <input type="radio"/> | <input type="radio"/> | <input type="radio"/> | <input type="radio"/> | <input type="radio"/> | <input type="radio"/> | <input type="radio"/> |

*10. XM keeps promotions as promised

| | 1 - Strongly Disagree | 2 | 3 | 4 | 5 | 6 | 7 - Strongly Agree |
|------------------|-----------------------|-----------------------|-----------------------|-----------------------|-----------------------|-----------------------|-----------------------|
| Importance | <input type="radio"/> | <input type="radio"/> | <input type="radio"/> | <input type="radio"/> | <input type="radio"/> | <input type="radio"/> | <input type="radio"/> |
| XM's Performance | <input type="radio"/> | <input type="radio"/> | <input type="radio"/> | <input type="radio"/> | <input type="radio"/> | <input type="radio"/> | <input type="radio"/> |

*11. XM keeps service as promised (Execution Time, No Re-Quotes)

| | 1 - Strongly Disagree | 2 | 3 | 4 | 5 | 6 | 7 - Strongly Agree |
|------------------|-----------------------|-----------------------|-----------------------|-----------------------|-----------------------|-----------------------|-----------------------|
| Importance | <input type="radio"/> | <input type="radio"/> | <input type="radio"/> | <input type="radio"/> | <input type="radio"/> | <input type="radio"/> | <input type="radio"/> |
| XM's Performance | <input type="radio"/> | <input type="radio"/> | <input type="radio"/> | <input type="radio"/> | <input type="radio"/> | <input type="radio"/> | <input type="radio"/> |

12. Please provide comments you may have

XM.COM Service Quality

Responsiveness

Instructions: The following statements are related with responsiveness. For each question please select how important it is for you, and how XM performs at that particular field.

*13. XM's employees give me prompt service

| | 1 - Strongly Disagree | 2 | 3 | 4 | 5 | 6 | 7 - Strongly Agree |
|------------------|-----------------------|-----------------------|-----------------------|-----------------------|-----------------------|-----------------------|-----------------------|
| Importance | <input type="radio"/> | <input type="radio"/> | <input type="radio"/> | <input type="radio"/> | <input type="radio"/> | <input type="radio"/> | <input type="radio"/> |
| XM's Performance | <input type="radio"/> | <input type="radio"/> | <input type="radio"/> | <input type="radio"/> | <input type="radio"/> | <input type="radio"/> | <input type="radio"/> |

*14. I receive prompt responses to my request by email, chat or other means

| | 1 - Strongly Disagree | 2 | 3 | 4 | 5 | 6 | 7 - Strongly Agree |
|------------------|-----------------------|-----------------------|-----------------------|-----------------------|-----------------------|-----------------------|-----------------------|
| Importance | <input type="radio"/> | <input type="radio"/> | <input type="radio"/> | <input type="radio"/> | <input type="radio"/> | <input type="radio"/> | <input type="radio"/> |
| XM's Performance | <input type="radio"/> | <input type="radio"/> | <input type="radio"/> | <input type="radio"/> | <input type="radio"/> | <input type="radio"/> | <input type="radio"/> |

*15. XM quickly resolves problems I encounter

| | 1 - Strongly Disagree | 2 | 3 | 4 | 5 | 6 | 7 - Strongly Agree |
|------------------|-----------------------|-----------------------|-----------------------|-----------------------|-----------------------|-----------------------|-----------------------|
| Importance | <input type="radio"/> | <input type="radio"/> | <input type="radio"/> | <input type="radio"/> | <input type="radio"/> | <input type="radio"/> | <input type="radio"/> |
| XM's Performance | <input type="radio"/> | <input type="radio"/> | <input type="radio"/> | <input type="radio"/> | <input type="radio"/> | <input type="radio"/> | <input type="radio"/> |

16. Please provide comments you may have

XM.COM Service Quality

Communication

Instructions: The following statements are related with communication. For each question please select how important it is for you, and how XM performs at that particular field.

*17. XM's employees give me individual attention

| | 1 - Strongly Disagree | 2 | 3 | 4 | 5 | 6 | 7 - Strongly Agree |
|------------------|-----------------------|-----------------------|-----------------------|-----------------------|-----------------------|-----------------------|-----------------------|
| Importance | <input type="radio"/> | <input type="radio"/> | <input type="radio"/> | <input type="radio"/> | <input type="radio"/> | <input type="radio"/> | <input type="radio"/> |
| XM's Performance | <input type="radio"/> | <input type="radio"/> | <input type="radio"/> | <input type="radio"/> | <input type="radio"/> | <input type="radio"/> | <input type="radio"/> |

*18. The contact person understands my specific needs

| | 1 - Strongly Disagree | 2 | 3 | 4 | 5 | 6 | 7 - Strongly Agree |
|------------------|-----------------------|-----------------------|-----------------------|-----------------------|-----------------------|-----------------------|-----------------------|
| Importance | <input type="radio"/> | <input type="radio"/> | <input type="radio"/> | <input type="radio"/> | <input type="radio"/> | <input type="radio"/> | <input type="radio"/> |
| XM's Performance | <input type="radio"/> | <input type="radio"/> | <input type="radio"/> | <input type="radio"/> | <input type="radio"/> | <input type="radio"/> | <input type="radio"/> |

*19. The contact person is knowledgeable

| | 1 - Strongly Disagree | 2 | 3 | 4 | 5 | 6 | 7 - Strongly Agree |
|------------------|-----------------------|-----------------------|-----------------------|-----------------------|-----------------------|-----------------------|-----------------------|
| Importance | <input type="radio"/> | <input type="radio"/> | <input type="radio"/> | <input type="radio"/> | <input type="radio"/> | <input type="radio"/> | <input type="radio"/> |
| XM's Performance | <input type="radio"/> | <input type="radio"/> | <input type="radio"/> | <input type="radio"/> | <input type="radio"/> | <input type="radio"/> | <input type="radio"/> |

*20. It is very convenient to contact employees when I have questions or complaints

| | 1 - Strongly Disagree | 2 | 3 | 4 | 5 | 6 | 7 - Strongly Agree |
|------------------|-----------------------|-----------------------|-----------------------|-----------------------|-----------------------|-----------------------|-----------------------|
| Importance | <input type="radio"/> | <input type="radio"/> | <input type="radio"/> | <input type="radio"/> | <input type="radio"/> | <input type="radio"/> | <input type="radio"/> |
| XM's Performance | <input type="radio"/> | <input type="radio"/> | <input type="radio"/> | <input type="radio"/> | <input type="radio"/> | <input type="radio"/> | <input type="radio"/> |

21. Please provide comments you may have

XM.COM Service Quality

Trust

Instructions: The following statements are related with trust. For each question please select how important it is for you, and how XM performs at that particular field.

*22. XM have a good reputation as a forex broker

| | 1 - Strongly Disagree | 2 | 3 | 4 | 5 | 6 | 7 - Strongly Agree |
|------------------|-----------------------|-----------------------|-----------------------|-----------------------|-----------------------|-----------------------|-----------------------|
| Importance | <input type="radio"/> | <input type="radio"/> | <input type="radio"/> | <input type="radio"/> | <input type="radio"/> | <input type="radio"/> | <input type="radio"/> |
| XM's Performance | <input type="radio"/> | <input type="radio"/> | <input type="radio"/> | <input type="radio"/> | <input type="radio"/> | <input type="radio"/> | <input type="radio"/> |

*23. I trust XM

| | 1 - Strongly Disagree | 2 | 3 | 4 | 5 | 6 | 7 - Strongly Agree |
|------------------|-----------------------|-----------------------|-----------------------|-----------------------|-----------------------|-----------------------|-----------------------|
| Importance | <input type="radio"/> | <input type="radio"/> | <input type="radio"/> | <input type="radio"/> | <input type="radio"/> | <input type="radio"/> | <input type="radio"/> |
| XM's Performance | <input type="radio"/> | <input type="radio"/> | <input type="radio"/> | <input type="radio"/> | <input type="radio"/> | <input type="radio"/> | <input type="radio"/> |

*24. I trust e-services provided by XM

| | 1 - Strongly Disagree | 2 | 3 | 4 | 5 | 6 | 7 - Strongly Agree |
|------------------|-----------------------|-----------------------|-----------------------|-----------------------|-----------------------|-----------------------|-----------------------|
| Importance | <input type="radio"/> | <input type="radio"/> | <input type="radio"/> | <input type="radio"/> | <input type="radio"/> | <input type="radio"/> | <input type="radio"/> |
| XM's Performance | <input type="radio"/> | <input type="radio"/> | <input type="radio"/> | <input type="radio"/> | <input type="radio"/> | <input type="radio"/> | <input type="radio"/> |

*25. I am comfortable dealing with financial transactions with XM

| | 1 - Strongly Disagree | 2 | 3 | 4 | 5 | 6 | 7 - Strongly Agree |
|------------------|-----------------------|-----------------------|-----------------------|-----------------------|-----------------------|-----------------------|-----------------------|
| Importance | <input type="radio"/> | <input type="radio"/> | <input type="radio"/> | <input type="radio"/> | <input type="radio"/> | <input type="radio"/> | <input type="radio"/> |
| XM's Performance | <input type="radio"/> | <input type="radio"/> | <input type="radio"/> | <input type="radio"/> | <input type="radio"/> | <input type="radio"/> | <input type="radio"/> |

*26. XM will not misuse my personal or account information

| | 1 - Strongly Disagree | 2 | 3 | 4 | 5 | 6 | 7 - Strongly Agree |
|------------------|-----------------------|-----------------------|-----------------------|-----------------------|-----------------------|-----------------------|-----------------------|
| Importance | <input type="radio"/> | <input type="radio"/> | <input type="radio"/> | <input type="radio"/> | <input type="radio"/> | <input type="radio"/> | <input type="radio"/> |
| XM's Performance | <input type="radio"/> | <input type="radio"/> | <input type="radio"/> | <input type="radio"/> | <input type="radio"/> | <input type="radio"/> | <input type="radio"/> |

*27. I am feeling safe providing sensitive information for online transactions (e.g. credit cards)

| | 1 - Strongly Disagree | 2 | 3 | 4 | 5 | 6 | 7 - Strongly Agree |
|------------------|-----------------------|-----------------------|-----------------------|-----------------------|-----------------------|-----------------------|-----------------------|
| Importance | <input type="radio"/> | <input type="radio"/> | <input type="radio"/> | <input type="radio"/> | <input type="radio"/> | <input type="radio"/> | <input type="radio"/> |
| XM's Performance | <input type="radio"/> | <input type="radio"/> | <input type="radio"/> | <input type="radio"/> | <input type="radio"/> | <input type="radio"/> | <input type="radio"/> |

*28. I feel that the risk associated with online transactions is low

| | 1 - Strongly Disagree | 2 | 3 | 4 | 5 | 6 | 7 - Strongly Agree |
|------------------|-----------------------|-----------------------|-----------------------|-----------------------|-----------------------|-----------------------|-----------------------|
| Importance | <input type="radio"/> | <input type="radio"/> | <input type="radio"/> | <input type="radio"/> | <input type="radio"/> | <input type="radio"/> | <input type="radio"/> |
| XM's Performance | <input type="radio"/> | <input type="radio"/> | <input type="radio"/> | <input type="radio"/> | <input type="radio"/> | <input type="radio"/> | <input type="radio"/> |

29. Please provide comments you may have

XM.COM Service Quality

Website content, functionality and product portfolio

Instructions: The following statements are related with website content, functionality and product portfolio . For each question please select how important it is for you, and how XM performs at that particular field.

*30. XM provides many services that I am looking for

| | 1 - Strongly Disagree | 2 | 3 | 4 | 5 | 6 | 7 - Strongly Agree |
|------------------|-----------------------|-----------------------|-----------------------|-----------------------|-----------------------|-----------------------|-----------------------|
| Importance | <input type="radio"/> | <input type="radio"/> | <input type="radio"/> | <input type="radio"/> | <input type="radio"/> | <input type="radio"/> | <input type="radio"/> |
| XM's Performance | <input type="radio"/> | <input type="radio"/> | <input type="radio"/> | <input type="radio"/> | <input type="radio"/> | <input type="radio"/> | <input type="radio"/> |

*31. XM maintains an up-to-date webpage

| | 1 - Strongly Disagree | 2 | 3 | 4 | 5 | 6 | 7 - Strongly Agree |
|------------------|-----------------------|-----------------------|-----------------------|-----------------------|-----------------------|-----------------------|-----------------------|
| Importance | <input type="radio"/> | <input type="radio"/> | <input type="radio"/> | <input type="radio"/> | <input type="radio"/> | <input type="radio"/> | <input type="radio"/> |
| XM's Performance | <input type="radio"/> | <input type="radio"/> | <input type="radio"/> | <input type="radio"/> | <input type="radio"/> | <input type="radio"/> | <input type="radio"/> |

*32. XM's webpage have the content that meets customers' needs

| | 1 - Strongly Disagree | 2 | 3 | 4 | 5 | 6 | 7 - Strongly Agree |
|------------------|-----------------------|-----------------------|-----------------------|-----------------------|-----------------------|-----------------------|-----------------------|
| Importance | <input type="radio"/> | <input type="radio"/> | <input type="radio"/> | <input type="radio"/> | <input type="radio"/> | <input type="radio"/> | <input type="radio"/> |
| XM's Performance | <input type="radio"/> | <input type="radio"/> | <input type="radio"/> | <input type="radio"/> | <input type="radio"/> | <input type="radio"/> | <input type="radio"/> |

*33. XM's website provides many useful tools (e.g. Economic Calendar, Trader's Dashboard, etc)

| | 1 - Strongly Disagree | 2 | 3 | 4 | 5 | 6 | 7 - Strongly Agree |
|------------------|-----------------------|-----------------------|-----------------------|-----------------------|-----------------------|-----------------------|-----------------------|
| Importance | <input type="radio"/> | <input type="radio"/> | <input type="radio"/> | <input type="radio"/> | <input type="radio"/> | <input type="radio"/> | <input type="radio"/> |
| XM's Performance | <input type="radio"/> | <input type="radio"/> | <input type="radio"/> | <input type="radio"/> | <input type="radio"/> | <input type="radio"/> | <input type="radio"/> |

*34. XM provides many useful services (e.g. E-mail Subscriptions, Trading Signals, etc.)

| | 1 - Strongly Disagree | 2 | 3 | 4 | 5 | 6 | 7 - Strongly Agree |
|------------------|-----------------------|-----------------------|-----------------------|-----------------------|-----------------------|-----------------------|-----------------------|
| Importance | <input type="radio"/> | <input type="radio"/> | <input type="radio"/> | <input type="radio"/> | <input type="radio"/> | <input type="radio"/> | <input type="radio"/> |
| XM's Performance | <input type="radio"/> | <input type="radio"/> | <input type="radio"/> | <input type="radio"/> | <input type="radio"/> | <input type="radio"/> | <input type="radio"/> |

35. Please provide comments you may have

XM.COM Service Quality

XM's Website Ease of Use

Instructions: The following statements are related with website ease of use. For each question please select how important it is for you, and how XM performs at that particular field.

*36. The organisation and structure of the online content is easy to follow

| | 1 - Strongly Disagree | 2 | 3 | 4 | 5 | 6 | 7 - Strongly Agree |
|------------------|-----------------------|-----------------------|-----------------------|-----------------------|-----------------------|-----------------------|-----------------------|
| Importance | <input type="radio"/> | <input type="radio"/> | <input type="radio"/> | <input type="radio"/> | <input type="radio"/> | <input type="radio"/> | <input type="radio"/> |
| XM's Performance | <input type="radio"/> | <input type="radio"/> | <input type="radio"/> | <input type="radio"/> | <input type="radio"/> | <input type="radio"/> | <input type="radio"/> |

*37. The use of XM's website requires a lot of effort

| | 1 - Strongly Disagree | 2 | 3 | 4 | 5 | 6 | 7 - Strongly Agree |
|------------------|-----------------------|-----------------------|-----------------------|-----------------------|-----------------------|-----------------------|-----------------------|
| Importance | <input type="radio"/> | <input type="radio"/> | <input type="radio"/> | <input type="radio"/> | <input type="radio"/> | <input type="radio"/> | <input type="radio"/> |
| XM's Performance | <input type="radio"/> | <input type="radio"/> | <input type="radio"/> | <input type="radio"/> | <input type="radio"/> | <input type="radio"/> | <input type="radio"/> |

*38. The use of XM's website is complicated

| | 1 - Strongly Disagree | 2 | 3 | 4 | 5 | 6 | 7 - Strongly Agree |
|------------------|-----------------------|-----------------------|-----------------------|-----------------------|-----------------------|-----------------------|-----------------------|
| Importance | <input type="radio"/> | <input type="radio"/> | <input type="radio"/> | <input type="radio"/> | <input type="radio"/> | <input type="radio"/> | <input type="radio"/> |
| XM's Performance | <input type="radio"/> | <input type="radio"/> | <input type="radio"/> | <input type="radio"/> | <input type="radio"/> | <input type="radio"/> | <input type="radio"/> |

39. Please provide comments you may have

XM.COM Service Quality

Satisfaction

Instructions: The following statements are related with your satisfaction. Please indicate your level of agreement by selecting the appropriate response.

***40. Overall, the service quality of XM is excellent**

1 - Strongly Disagree 2 3 4 5 6 7 - Strongly Agree

***41. Overall, XM reaches to my expectations of what makes a good forex broker**

1 - Strongly Disagree 2 3 4 5 6 7 - Strongly Agree

***42. Overall, I am very satisfied with XM's trading execution**

1 - Strongly Disagree 2 3 4 5 6 7 - Strongly Agree

***43. Overall, I am very satisfied with XM**

1 - Strongly Disagree 2 3 4 5 6 7 - Strongly Agree

***44. Overall, I am very satisfied with products and services provided by XM**

1 - Strongly Disagree 2 3 4 5 6 7 - Strongly Agree

***45. I will frequently use XM's products and services in the future**

1 - Strongly Disagree 2 3 4 5 6 7 - Strongly Agree

***46. I would strongly recommend XM to others**

1 - Strongly Disagree 2 3 4 5 6 7 - Strongly Agree

47. Please provide comments you may have

8.3 Appendix C – Coding Table

| Coding Research Data – e-ServQual Dimensions | Questionnaire Section | Item Reference Question |
|--|-----------------------|--|
| Reliability | 3 | <ul style="list-style-type: none"> • 8 • 9 • 10 • 11 |
| Responsiveness | 4 | <ul style="list-style-type: none"> • 13 • 14 • 15 |
| Communication | 5 | <ul style="list-style-type: none"> • 17 • 18 • 19 • 20 |
| Trust | 6 | <ul style="list-style-type: none"> • 22 • 23 • 24 • 25 • 26 • 27 • 28 |
| Website Content & Functionality – Product Portfolio | 7 | <ul style="list-style-type: none"> • 30 • 31 • 32 • 33 • 34 |
| Website Ease of Use | 8 | <ul style="list-style-type: none"> • 36 • 37 • 38 |

| Coding Research Data – e-ServQual Dimensions | Questionnaire Section | Item Reference Question |
|---|-----------------------|--|
| Satisfaction | 9 | <ul style="list-style-type: none"> • 40 • 41 • 42 • 43 • 44 • 45 • 46 |

8.4 Appendix D - Factor Analysis

Table 13 - Factor Analysis - Importance - Question 8 - 28

Rotated Component Matrix^a

| | Component | | | |
|-------|-----------|------|------|------|
| | 1 | 2 | 3 | 4 |
| Imp18 | .801 | .399 | .254 | .151 |
| Imp17 | .799 | .264 | .295 | .202 |
| Imp20 | .766 | .381 | .282 | .174 |
| Imp19 | .752 | .396 | .325 | .195 |
| Imp13 | .616 | .249 | .596 | .180 |
| Imp23 | .373 | .785 | .309 | .244 |
| Imp24 | .431 | .758 | .301 | .234 |
| Imp25 | .390 | .717 | .287 | .354 |
| Imp22 | .386 | .665 | .381 | .205 |
| Imp26 | .431 | .620 | .373 | .373 |
| Imp27 | .320 | .592 | .294 | .545 |
| Imp08 | .193 | .397 | .758 | .113 |
| Imp09 | .338 | .126 | .739 | .277 |
| Imp11 | .215 | .575 | .636 | .089 |
| Imp10 | .308 | .430 | .621 | .121 |
| Imp15 | .520 | .268 | .610 | .260 |
| Imp14 | .572 | .288 | .594 | .228 |
| Imp28 | .230 | .345 | .225 | .828 |

Extraction Method: Principal Component Analysis.
Rotation Method: Varimax with Kaiser Normalization.
a. Rotation converged in 9 iterations.

Table 14 - Factor Analysis - Importance - Question 30 - 38

Rotated Component Matrix^a

| | Component | |
|-------|-----------|-------|
| | 1 | 2 |
| Imp31 | .937 | -.028 |
| Imp32 | .924 | -.076 |
| Imp30 | .907 | -.084 |
| Imp33 | .891 | -.114 |
| Imp34 | .882 | -.128 |
| Imp36 | .872 | -.019 |
| Imp38 | -.034 | .950 |
| Imp37 | -.121 | .940 |

Extraction Method: Principal Component Analysis.

Rotation Method: Varimax with Kaiser Normalization.

a. Rotation converged in 3 iterations.

Table 15 - Factor Analysis - Performance - Question 8 - 28

Rotated Component Matrix^a

| | Component | | | |
|--------|-----------|------|------|------|
| | 1 | 2 | 3 | 4 |
| Perf18 | .794 | .380 | .223 | .155 |
| Perf17 | .788 | .353 | .232 | .187 |
| Perf19 | .779 | .432 | .220 | .164 |
| Perf20 | .769 | .359 | .192 | .240 |
| Perf13 | .756 | .179 | .440 | .212 |
| Perf15 | .718 | .156 | .469 | .226 |
| Perf14 | .703 | .180 | .459 | .261 |
| Perf23 | .368 | .749 | .361 | .284 |
| Perf24 | .418 | .711 | .356 | .315 |
| Perf25 | .395 | .688 | .282 | .390 |
| Perf22 | .362 | .670 | .419 | .267 |
| Perf26 | .384 | .509 | .330 | .492 |
| Pef08 | .249 | .398 | .764 | .069 |
| Perf11 | .253 | .400 | .707 | .194 |
| Perf09 | .423 | .134 | .692 | .269 |
| Perf10 | .337 | .277 | .638 | .303 |
| Perf28 | .214 | .295 | .214 | .843 |
| Perf27 | .350 | .509 | .284 | .633 |

Extraction Method: Principal Component Analysis.

Rotation Method: Varimax with Kaiser Normalization.

a. Rotation converged in 6 iterations.

Table 16 - Factor Analysis - Performance - Question 30 - 38

Rotated Component Matrix^a

| | Component | |
|--------|-----------|-------|
| | 1 | 2 |
| Perf31 | .924 | -.026 |
| Perf32 | .908 | -.007 |
| Perf30 | .888 | -.046 |
| Perf33 | .880 | -.050 |
| Perf34 | .880 | -.079 |
| Perf36 | .857 | .014 |
| Perf38 | .009 | .942 |
| Perf37 | -.077 | .938 |

Extraction Method: Principal Component Analysis.

Rotation Method: Varimax with Kaiser Normalization.

a. Rotation converged in 3 iterations.

Table 17 - Factor Analysis - Satisfaction - Questions 40 - 46

Component Matrix^a

| | Component |
|-------|-----------|
| | 1 |
| Sat43 | .970 |
| Sat41 | .956 |
| Sat46 | .943 |
| Sat40 | .939 |
| Sat44 | .933 |
| Sat45 | .928 |
| Sat42 | .920 |

Extraction Method: Principal Component Analysis.

a. 1 components extracted.